

TOOLS
FOCUS LEADS
PROFESSIONAL

VIGEX SMS

VIM  **LION**[®]

 **VIGOR**
TRADING L.L.C.

IMPORTER, EXPORTER & GENERAL TRADING
Tel.: +9714 223 6660, Fax: +9714 228 5578
P.O.Box: 115130, Dubai-U.A.E.

VIGEX

PROFESSIONAL PRODUCTS

PRODUCT BROCHURE

A PROFESSIONAL COMPANY FOR
AUTOMOTIVE TOOLS HAND TOOLS POWER TOOLS

FOCUS LEADS PROFESSIONAL

2022-2023



Vigor Trading L.L.C E-mail: vfn@emirates.net.ae

VIGOR TRADING L.L.C is one of the reputed trading company, specialist in hardware, hand tools, power tools, and machinery has been established in 1993 located in whole sale market in Deira, Dubai, U.A.E.

Our Valuable and experienced team are dedicated to approach the highest customer satisfaction through supplying the variety of quality tools.

TOOLS
FOCUS LEADS
PROFESSIONAL



VIGEX **SMS** **VIM**  **LION**[®]

VIGOR TRADING L.L.C has been growing steadily achieving its mission as a supplier of a comprehensive range of hand and power tools and machinery. being honest, professional, responsibility is our company principal.



www.vigortae.com



WhatsApp business account

■ **IMPACT DRILL**

Z1J-VG-6BE



Voltage:230/110V
Frequency:50/60Hz
Power Input:400W
NO-Load speed:0-3000min⁻¹
Drill dia.(max):6mm

■ **IMPACT DRILL**

Z1J-VG2-13E



Voltage:230/110V
Frequency:50/60Hz
Power Input:500W
NO-Load speed:0-2700min⁻¹
Drill dia.(max):13mm

■ **IMPACT DRILL**

Z1J-VG6-13E



Voltage:230/110V
Frequency:50/60Hz
Power Input:750/650W
NO-Load speed:0-2800min⁻¹
Drill dia.(max):13mm

■ **IMPACT DRILL**

Z1J-VG-13E



Voltage:230/110V
Frequency:50/60Hz
Power Input:500W
NO-Load speed:0-2800min⁻¹
Drill dia.(max):13mm

■ **IMPACT DRILL**

Z1J-VG4-13aE



Voltage:230/110V
Frequency:50/60Hz
Power Input:710W
NO-Load speed:0-3000min⁻¹
/ 0-2800min⁻¹
Drill dia.(max):13mm

■ **IMPACT DRILL**

Z1J-VG3-13E



Voltage:230/110V
Frequency:50/60Hz
Power Input:650W
NO-Load speed:0-2800min⁻¹
Drill dia.(max):13mm

■ **IMPACT DRILL**

Z1J-VG4-13BE



Voltage:230/110V
Frequency:50/60Hz
Power Input:810W
NO-Load speed:0-3000min⁻¹/ 0-2800min⁻¹
Drill dia.(max):13mm

**910W
HEAVY DUTY IMPACT DRILL**



Drill capacity:13mm
Rated voltage:220-240V
frequency:50-60Hz
NO-Load speed:0-3000rpm

13MM IMPACT DRILL



Voltage:220-240V
Quency:50-60Hz
No. : 0-2800rpm
Drill :13mm
750W

13MM IMPACT DRILL

Voltage:220-240v
Frequency:50-60Hz
Power input:1050w
No-load speed:0-3000rpm
Drill capacity:1-13mm



■ **COMBINED TOOLS**

Packing size:43×31.5×26
G.W/M.W:15/14Kg(5set)



COMBINED TOOLS

Packing size:68×40×32
G.W/M.W:25/23Kg(5set)



■ **COMBINED TOOLS**

Packing size:57.5×40.5×36
G.W/M.W:22.5/21.5Kg



■ **COMBINED TOOLS**

Packing size:45.5×45.5×29.5
G.W/M.W:26/24Kg(5set)



■ **COMBINED TOOLS**

Packing size:50×38×34.5
G.W/M.W:22/20Kg(5set)



■ **COMBINED TOOLS**

Packing size:50×38×34.5
G.W/M.W:22/20Kg(5set)



10mm KEYLESS CHUCK
CORDLESS DRILL

No-Load speed:0-580/min⁻¹
3-5 Hr charge time
15+1 torque setting
Variable speed
Forward/reverse lever
Full accessories:
6PC screwdriver Bit
6PC twist drill
Magnetic bits holder



12V CORDLESS DRILL KIT
CORDLESS DRILL

20 torque setting
Two speed control
10mm keyless chuck
12pcs sockets
1pcs connector
34pcs screwdriver bits
Convenient carrying case
1 hour quick recharge



S1M-VG-115/125
ANGLE GRINDER

Voltage:230/110V Frequency:50/60Hz
Power Input:850W
NO-Load speed:11000min⁻¹
Diameter:115mm/125mm



S1M-VG-115B1
ANGLE GRINDER

Voltage:230/110V Frequency:50/60Hz
Power Input:500W
NO-Load speed:11000min⁻¹ Diameter:115mm



S1M-VG-115/115A/125A
ANGLE GRINDER

Voltage:230/110V Frequency:50/60Hz
Power Input:500W/600W
NO-Load speed:11000min⁻¹
Diameter:115mm/125mm



S1M-VG-115D
ANGLE GRINDER

Voltage:230/110V Frequency:50/60Hz
Power Input:500W
NO-Load speed:11000min⁻¹
Diameter:115mm



100MM ANGLE GRINDER

Voltage:220-240V
Frequency:50/60Hz
Input power:500W
NO-Load speed 11000rpm
Diameter of disc blade:100mm



S1M-VG-180B(230)
ANGLE GRINDER

Voltage:230/110V Frequency:50/60Hz
Power Input:1600W
Diameter:180MM/230mm
NO-Load speed:6500min⁻¹



S1M-VG-230F
ANGLE GRINDER

Voltage:230/110V Power Input:2200W
Diameter:230mm
Frequency:50/60Hz
NO-Load speed:6500min⁻¹



S1M-VG-230E
ANGLE GRINDER

Voltage:230/110V Power Input:1700W
Diameter:230mm
Frequency:50/60Hz
NO-Load speed:6500min⁻¹



115MM ANGLE GRINDER

Voltage:220~240V Frequency:50/60Hz
 Input power:1010W NO-Load speed 11000rpm
 Diameter of disc blade:115mm



S1M-VG4-115
ANGLE GRINDER
 115MM/850W



S1M-VG-180D
ANGLE GRINDER

Voltage:230/110V Frequency:50/60Hz
 Power Input:1200W/1300W
 NO-Load speed:3000-8000min⁻¹
 Diameter:180mm



COMBINED TOOLS

Packing size:70×58×35
 G.W/M.W:18.5/17.5Kg(2set)



5" ANGLE GRINDER & 7" POLISHER

1 Each of 5" grinding wheel
 Diamond cutting wheel
 7" Sander paper polishing bonnet
 Blow case, color sleeve



POLISHING-SANDER S1P-VG-180AH/180AE

Voltage:230/110V Frequency:50/60Hz
 Power Input:900W
 NO-load speed:900-3800min⁻¹ 1500-3800min⁻¹
 Diameter:115mm/125mm/150mm/180mm



POLISHING-SANDER S1P-VG-180BH/180BE

Voltage:230/110V Frequency:50/60Hz
 Power Input:1200/1300W
 NO-load speed:900-3000min⁻¹ 1500-3000min⁻¹
 Diameter:180mm/230mm



POLISHING-SANDER S1P-VG-180C

Voltage:230/110V Frequency:50/60Hz
 Power Input:1300W
 NO-load speed: 1500-3000min⁻¹
 Diameter:180mm



POLISHING-SANDER S1P-VG2-180BE

1800MM/1300W
 1500-3000R/min

S1M-VG3-125B/125E

ANGLE GRINDER & POLISHING

Voltage:230/110V Frequency:50/60Hz
 Power Input:900W/6.18A
 NO-load speed:10000min⁻¹ 3000-10000min⁻¹ 4500-10000min⁻¹
 Diameter:115mm/125mm Polisher Diameter:180mm





■ JIG SAW M1Q-VG-55

Voltage: 230/110V
 Frequency: 50/60Hz
 Power Input: 350W
 No-load speed: 500-3000min⁻¹
 Stroke: 18mm
 Bevel cuts: ±45°
 Cutting /Wood: 55mm
 Cutting/Aluminium: 12mm
 Cutting/Non-alloyed steel: 6mm



■ JIG SAW M1Q-VG-55E

Voltage: 230/110V
 Frequency: 50/60Hz
 Power Input: 350W
 No-load speed: 500-3000min⁻¹
 Stroke: 18mm
 Bevel cuts: ±45°
 Cutting /Wood: 55mm
 Cutting/Aluminium: 12mm
 Cutting/Non-alloyed steel: 6mm



■ JIG SAW M1Q-VG-80E

Voltage: 230/110V
 Frequency: 50/60Hz
 Power Input: 750W
 No-load speed: 500-3000min⁻¹
 Stroke: 22mm
 Bevel cuts: ±45°
 Cutting /Wood: 80mm
 Cutting/Aluminium: 16mm
 Cutting/Non-alloyed steel: 6mm



■ JIG SAW M1Q-VG-65E

Voltage: 230/110V
 Frequency: 50/60Hz
 Power Input: 600W
 No-load speed: 500-3000min⁻¹
 Stroke: 18mm
 Bevel cuts: ±45°
 Cutting /Wood: 65mm
 Cutting/Aluminium: 12mm
 Cutting/Non-alloyed steel: 6mm



■ JIG SAW M1Q-VG-110E

Voltage: 230/110V
 Frequency: 50/60Hz
 Power Input: 750W
 No-load speed: 500-3000min⁻¹
 Stroke: 22mm
 Bevel cuts: ±45°
 Cutting /Wood: 110mm
 Cutting/Aluminium: 12mm
 Cutting/Non-alloyed steel: 6mm

ROTARY HAMMER DRILL

Rated voltage:220-240V
 Rated frequency:50-60Hz
 Drill capacity:30mm
 NO-Load speed:0-850min⁻¹
 Hammer time:0-5200min⁻¹



ROTARY HAMMER DRILL

Rated voltage:220-240V
 Rated frequency:50-60Hz
 Drill capacity:40mm
 No-load speed:0-500min⁻¹
 Hammer time:0-3500min⁻¹
 Convenient carrying case



■ PLANER M1B-VG-82 x 2

Voltage: 230/110v
 Frequency: 50/60HZ
 Power Input: 710W
 No-load speed: 1600min⁻¹
 Cutting width: 82mm
 Cutting Depth: 0-2mm



HEAVY DUTY ROTARY HAMMER DRILL

RATED VOLTAGE:220-240V/AC
 RATED FREQUENCY:50HZ
 DRILL CAPACITY:26MM
 NO-LOAD SPEED:850min⁻¹
 HAMMER FREQUENCY:3150min⁻¹
 INCLUDING 2 PC CHISELS AND
 5 PC SDS DRILLS
 CONVENIENT CARRYING CASE



■ COMBINED TOOLS

Packing size:70 x 32 x 25
 G.W/M.W:22/20Kg(8set)



ED002A04

IMPACT DRILL W/CHUCK KEY 13MM 710W

- ◊ Voltage:220/240V
- ◊ Frequency:50/60Hz
- ◊ Power Input:710W
- ◊ NO-Load speed:0-2800/min
- ◊ Drill dia.(max):13mm



MR592

HEAVY DUTY IMPACT DRILL 13MM 850W

- ◊ Voltage:220V
- ◊ Frequency:50Hz
- ◊ Power Input:850W
- ◊ NO-Load speed:0-3000/min
- ◊ Drill dia.(max):13mm



VIM18V

18V CORDLESS DRILL 1 EXTRA BATTERY (NORMAL CHARGER) IN BMC

- ◊ 16+1 torque setting
- ◊ Forward/ reverse lever
- ◊ 18V 1.3AH Ni-cd Battery

VG02G0083

LI-ION CORDLESS RECIPROCATING SAW 18V 1.5AH

- ◊ No-load speed: 0-3000Strokes/min Stroke length: 22mm
- ◊ Cutting depth in Wood: 60mm Cutting depth in Steel: 5mm
- 18V 1.5Ah LI-ion X 2PCS



VG02Z0007

ELECTRIC SPRAY GUN,80W

- ◊ VOLTAGE 220-240V
- ◊ FREQUENCY: 50HZ
- ◊ INPUT POWER: 80W
- ◊ OPERATION SPEED: 280ML/MIN
- ◊ CAPACITY: 800ML

IO7101

HEAVY DUTY IMPACT DRILL

- ◊ 220V/50HZ UK PLUG WITH 3 PINS.
- 710W 220V~50Hz
- 0-2800r/min 13mm



WT02F1529

CORDLESS DRILL WITH 24PCS TOOLS. 21V 25Nm



EBP7801

ELECTRIC BARREL PUMP

- ◊ Voltage: 220v
- ◊ Input Power: 780w
- ◊ Max High: 7m
- ◊ Max Delivery Capacity: 100l/min
- ◊ Outlet Dia.: 25mm
- ◊ Inlet Dia.: 44mm
- ◊ Tube Length: 92mm
- ◊ Tube Outlet Dia.: 41.9mm
- ◊ Tube Inlet Dia.: 38.0mm
- ◊ Head: 7m



WT07B0039

PORTABLE AIR MOVER

- ◊ 220V/50HZ 150W
- ◊ Air Volume: 800m3/h 10.5/13/ 14.3m/s

WT02G2009

ELECTRIC SPRAY GUN

- ◊ Voltage: 230-240V/50Hz
- ◊ Motor speed: 35000/min
- ◊ Input power: 400W
- ◊ Container capacity: 800ml
- ◊ Nozzle size: ø2.5mm
- ◊ Max. flow rate: 850ml/min
- ◊ Max. viscosity: 100 DIN-(Water)



EC013A02

TABLE SAW12"

- ◊ Voltage: 220-240v
- ◊ Freequence: 50-60hz
- ◊ Input Power: 50hz
- ◊ No Load Speed: 2950rpm
- ◊ Cutting Angle: 0 - 45°
- ◊ Max Cutting Capacity: 50-87mm



VT02A0075

8" DIAMOND CORE DRILL

- ◊ Rated voltage: 220V
- ◊ Frequency: 50Hz
- ◊ Rated input power: 4000W
- ◊ No load speed: 700rpm
- ◊ Max. drilling diameter: 205mm



PT107504

ELECTRIC PIPE THREADER

- ◊ Rated Voltage: 230v
- ◊ Frequency: 50hz
- ◊ Rated Input Power: 750w
- ◊ No Load Speed: 10/22r/min
- ◊ Applicable Pipe Threader: 1/2"-4"
- ◊ With Stand.



PT27501

ELECTRIC PIPE THREADER

- ◊ Rated Voltage: 230v
- ◊ Frequency: 50hz
- ◊ Rated Input Power: 750w
- ◊ No Load Speed: 28r/min
- ◊ Applicable Pipe Threader: 1/2"-2"
- ◊ With Stand.



WT02D0024

ELECTRIC HIGH PRESSURE

- ◊ 230V/50HZ, 1500W,
- ◊ WORKING PRESSURE: 50-90BAR



WT02A0077

12" DIAMOND CORE DRILL

- ◊ Rated voltage: 220v
- ◊ frequency: 50hz
- ◊ rated inputed power: 4650w
- ◊ no load speed: 360/560rpm/min
- ◊ max.drilling diamter :305mm



FV003A02

DIESEL HIGH PRESSURE WASHER, DIESEL ENGINE WITH TYRES 3600PSI



FG001B01

GASOLINE BRUSH CUTTER & GRASS TRIMMER

- ◊ Displacement: 25.4cc, Power: 0.75kw
- ◊ Cutting Diameter: 255mm (brush Cutter), 415mm (grass Trimmer).

WT02Z0009

BAG SEWING MACHIN

- ◊ 220-230V/50HZ





WT02C0079

WOOD LATHE MACHINE 330MM

- 350w, speed: 50-3500rpm,
- Max cutting dia.: 250mm,
- Cutting length: 330mm
- Exterior size: 760*320*345mm



ERA03

PORTABLE PIPE THREADER MACHINE

- Voltage: 220-240V*
- Quency: 50-60Hz
- No.: 22/min
- Power: 1800W



WT06C0012

STRETCHER SPRAYER

- Displacement: 163CC
- Height range: 7 ~ 15m
- Mating Power: 168F
- Standard Power: 3.1/3600r/min
- Fuel consumption: ≤ 395g/kw.h
- Working Pressure: 2.0 ~ 3.5MPa
- Plunger Diameter: 30mm Stroke: 22mm
- Net weight: 30kg Fuel tank capacity: 3.6L



ES002A01

HEAVY DUTY HAND DRILL STAND



WT02C0034

POWER PIPE CUTTER

- 220v/50hz, 750w
- N.V.: 70kgs
- Blade/pipe cutting range: 2-1/2" to 12"



WT02C0034

ELECTRIC PAINT SPRAYER

- 1000CC
- 450W



WT21MS250

MEAT CUTTING SAW 550W

- Voltage: 220-240v
- Frequency: 50-60hz
- Max cutting depth: 240mm
- Max cutting width: 250mm
- Table size: 470x800mm
- Sliding rang of table: 265mm



V130

BONE SAW

- Voltage: 220V
- Frequency: 50Hz
- Power: 0.65kW
- Blade wheel diameter: 1400mm
- Blade speed: 15m/s



STEEL BAR BENDER

WT02C0047

- Voltage: 380v/50hz
- Motor Power: 3kw-4hp
- Max Bending Dia: 6-40mm
- Automatic operation



STEEL BAR CUTTER

WT02C0048

- Voltage: 380v/50hz
- Motor Power: 3kw-4hp
- Max Cutting Dia: 6-40mm

GARDEN SUBMERSIBLE PUMP

V750

- 230/50HZ,
- INPUT POWER: 0.75KW/1.0HP,
- MAX. HEAD: 10M,
- MAX. FLOW: 300L/MIN.
- 6M VDE CABLE.
- 1 PC INTO NEUTRAL BOX.



PETROL LAWN MOWER

FG001B02

- Art.xym168-2
- 460mm/4.0hp
- With self-propelled

FG001C01

- Art.xym168-2b
- 460mm/5.0hp
- With self-propelled



STAINLESS STEEL DRY&WET VACUUM CLEANER

02D0019

- 230V/50HZ,
- VDE CABLE, EURO PLUG
- 2000W/70L TWO MOTOR

02D0020

- 230V/50HZ,
- VDE CABLE, EURO PLUG
- 2000W/80L TWO MOTOR

WT02D0021

- 230V/50HZ,
- VDE CABLE, EURO PLUG
- 80LTR 3000W(3MOTOR)



STAINLESS STEEL VACUUM CLEANER

WT02D0013

- 230V/50HZ VED CABLE
- 1200W/20L

WT02D0014

- 230V/50HZ VED CABLE
- 1200W/30L

WT02D0015

- 230V/50HZ VED CABLE
- 1200W/60L

WT02D0017

- 230V/50HZ VED CABLE
- 1400W/30L

WT02D0018

- 230V/50HZ VED CABLE
- 1400W/60L



MAGNETIC DRILL

ED006A07

- 230V/50HZ
- 1200W
- DRILLING DIA.23MM
- EURO PLUG IN WOOD CASE

ED006A08

- 230V/50HZ
- 1400W
- DRILLING DIA.28MM
- EURO PLUG IN WOOD CASE

ED006A09

- 230V/50HZ
- 1600W
- DRILLING DIA.32MM
- EURO PLUG IN WOOD CASE



WT04E0024

GASOLINE EARTH AUGER 52CC

- 52CC Displacement
- Rated Output Power: 1.45Kw
- Max engine speed: 9000±500rpm
- Idling speed: 3000±200rpm
- Fuel tank capacity: 1.2 Litre



WOOD BAND SAW MACHINE

- EC004A01
 - 6"/140MM
 - 250W
- EC004A04
 - 12"/305MM
 - 750W



CUT OFF MACHINE

- WT02C0029
 - 3phase
 - 380v/50hz,3.0kw/
 - 400mm blade size
- WT02C0028
 - 16" 1phase
 - 220v/50hz,2.2kw/
 - 400mm blade size



HAND FLOOR POLISHER

- HF192205
 - Voltage: AC220V
 - Frequency: 50HZ
 - Rated power: 1100W
 - Speed: 175/min
 - Disc: 17"/430mm
 - 12M. CABLE



ELECTRIC HVLV PAINT SPRAYER

- ER01DA05
 - Voltage: 220-240V(50-60Hz)
 - Power: 600W
 - Rotary Speed: 31000RPM



MOVABLE VENTILATOR

- WT0220052
 - 24" 2200W 220V/50Hz



PORTABLE VENTILATOR

- WT02E0054
 - 10" 280W
- WT02E0055
 - 12" 370W



PORTABLE VENTILATOR

- WT02Z9051
 - 16" 550W 220V/50Hz



FLEXIBLE DUCT

- 10" Length: 5m
- 12" Length: 5m
- 16" Length: 5m
- 24" Length: 5m

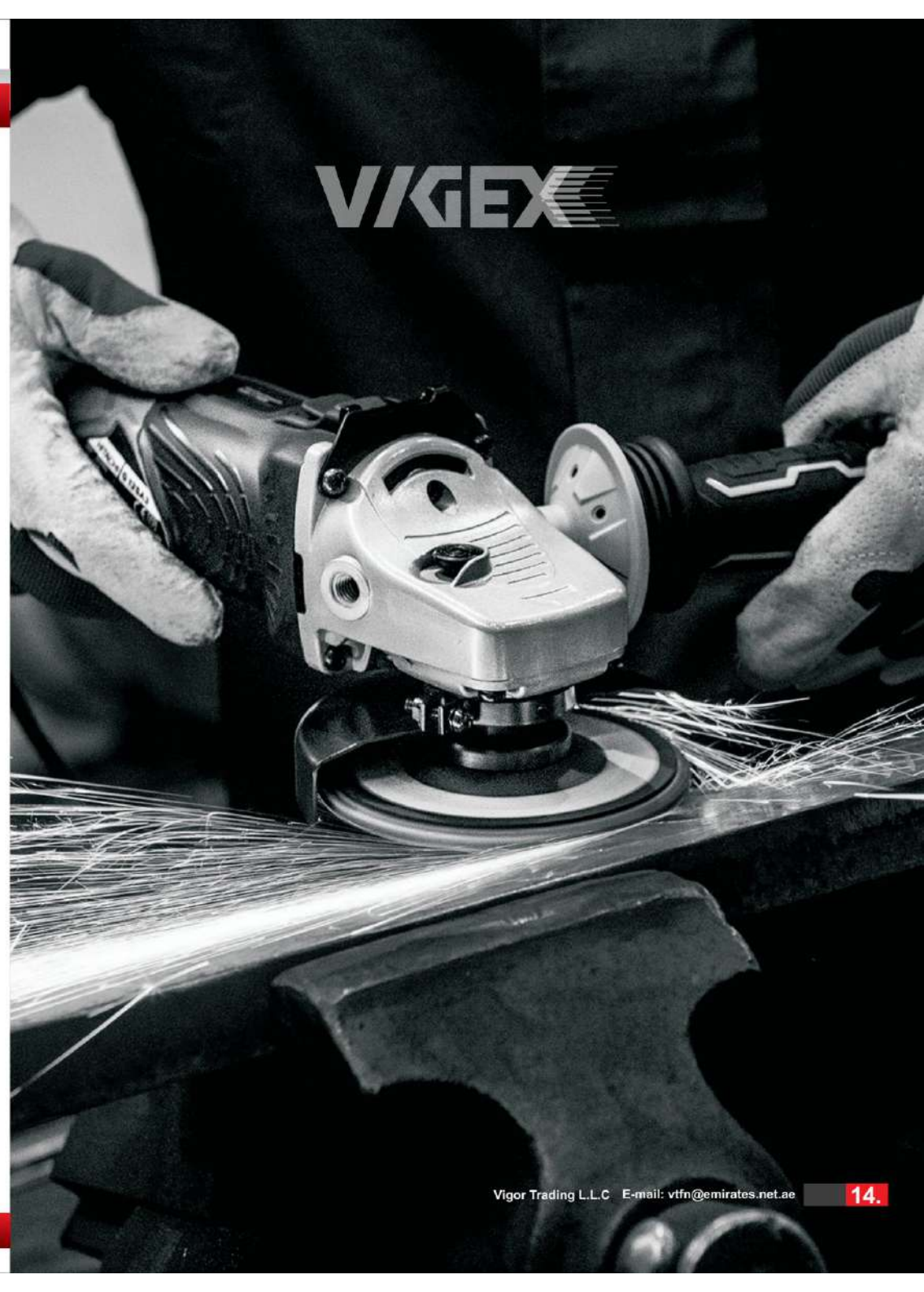



**ELECTRIC HOIST
VG200A**

- Latest European Standard Attestation CE, GS, EMC
- With urgent Stop Switch and reinforced breaking switch with position limit, protection class up to IP54, with thermal prevention device
- Voltage: 220-240V/50-60Hz
- Input Power: 510w
- Rate load (Single/Double): 100/200kg
- Lifting speed: 20/10m/min
- Lifting height: 12/6m

**Rate load
200KGS
Double**



**ELECTRIC HOIST
VG500A**

- Latest European Standard Attestation CE, GS, EMC
- With urgent Stop Switch and reinforced breaking switch with position limit, protection class up to IP54, with thermal prevention device
- Voltage: 220-240V/50-60Hz
- Input Power: 1020w
- Rate load (Single/Double): 250/500kg
- Lifting speed: 10/5m/min
- Lifting height: 12/6m

**Rate load
500KGS
Double**



**ELECTRIC HOIST
VG800A**

- Latest European Standard Attestation CE, GS, EMC
- With urgent Stop Switch and reinforced breaking switch with position limit, protection class up to IP54, with thermal prevention device
- Voltage: 220-240V/50-60Hz
- Input Power: 1250w
- Rate load (Single/Double): 400/800kg
- Lifting speed: 8/4m/min
- Lifting height: 12/6m

**Rate load
800KGS
Double**



**ELECTRIC HOIST
VG1000A**

- Latest European Standard Attestation CE, GS, EMC
- With urgent Stop Switch and reinforced breaking switch with position limit, protection class up to IP54, with thermal prevention device
- Voltage: 220-240V/50-60Hz
- Input Power: 1600w
- Rate load (Single/Double): 500/1000kg
- Lifting speed: 8/4m/min
- Lifting height: 12/6m

**Rate load
1000KGS
Double**



**ELECTRIC HOIST
VG1200A**

- Latest European Standard Attestation CE, GS, EMC
- With urgent Stop Switch and reinforced breaking switch with position limit, protection class up to IP54, with thermal prevention device
- Voltage: 220-240V/50-60Hz
- Input Power: 1800w
- Rate load (Single/Double): 600/1200kg
- Lifting speed: 8/4m/min
- Lifting height: 12/6m

**Rate load
1200KGS
Double**



ELECTRIC HOIST

- ART.PM1000C 2110W 1000KGS/
- ART.PA1200A 1800W 600/1200KGS/
- ART.PA1000A 1600W 500/1000KGS/
- ART. PA800A 1250W 400/800KGS/
- ART. PA500A 1020W 250/500KGS/
- ART. PA200A 510W 100/200KGS/
- ART.PM1200C 2310W 1200KGS/
- ART.PM800C 1760W 800KGS/
- ART.PM500C 1170W 500KGS/
- ART.PM200C 660W 200KGS



FR200T

300W 200mm PLASTIC FILM SEALER

Highly reliable and durable, Great for seal and cut shrink, length up to 200mm, Can seal up to 0.01-0.4mm thick film. Wire sealer, seal and cut in one step. Film and bags. No extra cutter is needed. Provides excellent air & watertight seal. Absolutely trouble free. Satisfaction guaranteed. Replacement kits and parts always available when you need them.

SOURCE: AC220V-240V 50HZ-60HZ
POWER: 300W
SEAL LENGTH: 200mm
SEAL WIDTH: 2.8mm
SEAL THICKNESS: 0.01-0.4mm



FR300T

400W 300mm PLASTIC FILM SEALER

Highly reliable and durable, Great for seal and cut shrink, length up to 300mm, Can seal up to 0.01-0.4mm thick film. Wire sealer, seal and cut in one step. Film and bags. No extra cutter is needed. Provides excellent air & watertight seal. Absolutely trouble free. Satisfaction guaranteed. Replacement kits and parts always available when you need them.

SOURCE: AC220V-240V 50HZ-60HZ
POWER: 400W
SEAL LENGTH: 300mm
SEAL WIDTH: 2.8mm
SEAL THICKNESS: 0.01-0.4mm



FR200A

**300W 200mm
ABS housing material**

Highly reliable and durable, Great for seal and cut shrink, length up to 200mm, Can seal up to 0.01-0.6mm thick film. Wire sealer, seal and cut in one step. Film and bags. No extra cutter is needed. Provides excellent air & watertight seal. Absolutely trouble free. Satisfaction guaranteed. Replacement kits and parts always available when you need them.

SOURCE: AC220V-240V 50HZ-60HZ
POWER: 300W
SEAL LENGTH: 200mm
SEAL WIDTH: 2.8mm
SEAL THICKNESS: 0.01-0.6mm



FR300A

**400W 300mm
ABS housing material**

Highly reliable and durable, Great for seal and cut shrink, length up to 300mm, Can seal up to 0.01-0.6mm thick film. Wire sealer, seal and cut in one step. Film and bags. No extra cutter is needed. Provides excellent air & watertight seal. Absolutely trouble free. Satisfaction guaranteed. Replacement kits and parts always available when you need them.

SOURCE: AC220V-240V 50HZ-60HZ
POWER: 400W
SEAL LENGTH: 300mm
SEAL WIDTH: 2.8mm
SEAL THICKNESS: 0.01-0.6mm



FR400A

**500W 400mm
ABS housing material**

Highly reliable and durable, Great for seal and cut shrink, length up to 400mm, Can seal up to 0.01-0.6mm thick film. Wire sealer, seal and cut in one step. Film and bags. No extra cutter is needed. Provides excellent air & watertight seal. Absolutely trouble free. Satisfaction guaranteed. Replacement kits and parts always available when you need them.

SOURCE: AC220V-240V 50HZ-60HZ
POWER: 500W
SEAL LENGTH: 400mm
SEAL WIDTH: 2.8mm
SEAL THICKNESS: 0.01-0.6mm

PLASTIC FILM SEALER



FR400-L
500W 400mm



Highly reliable and durable, Great for seal and cut shrink, length up to 400mm, Can seal up to 0.01-0.6mm thick film. Wire sealer, seal and cut in one step. Film and bags. No extra cutter is needed. Provides excellent air & watertight seal. Absolutely trouble free. Satisfaction guaranteed. Replacement kits and parts always available when you need them.

Voltage: 220-240V
Frequency: 50/60Hz
Seal length: 400mm
Seal width: 2.8mm
Seal thickness: 0.01-0.6mm

Aluminium housing material



500W/300MM

Voltage: 220-240V
Frequency: 50/60Hz
Seal length: 300mm
Seal width: 3mm
Seal thickness: 0.02-0.6mm



500W/400MM

Voltage: 220-240V
Frequency: 50/60Hz
Seal length: 400mm
Seal width: 3mm
Seal thickness: 0.02-0.6mm



600W/500MM

Voltage: 220-240V
Frequency: 50/60Hz
Seal length: 500mm
Seal width: 3mm
Seal thickness: 0.02-0.6mm



700W/600MM

Voltage: 220-240V
Frequency: 50/60Hz
Seal length: 600mm
Seal width: 3mm
Seal thickness: 0.02-0.6mm



800W/700MM

Voltage: 220-240V
Frequency: 50/60Hz
Seal length: 700mm
Seal width: 3mm
Seal thickness: 0.02-0.6mm



PLASTIC FILM SEALER

FRN500 600W 500mm

Highly reliable and durable, Great for seal and cut shrink. Wire sealer, seal and cut in one step. Film and bags. No extra cutter is needed. Provides excellent air & watertight seal. Replacement kits and parts always available when you need them.

Aluminium housing material

Voltage: 220-240V
Frequency: 50/60Hz
Seal length: 500mm
Seal width: 2.8mm
Seal thickness: 0.01-0.4mm



HIGH-SPEED PEDAL SEALER

Highly reliable and durable, Great for seal and cut shrink. Wire sealer, seal and cut in one step. Film and bags. No extra cutter is needed. Provides excellent air & watertight seal. Replacement kits and parts always available when you need them.



Model: VG02512

Model: WT02512
 Voltage: 230/110V
 Frequency: 50/60Hz
 Input power: 250(350)W
 Drilling cap.: 1.5-13mm
 Spindle travel: 50mm
 Spindle taper: B16(JT33)
 Speed of spindle: 5
 Rotary radius of table: 104mm
 Table size: 160X165mm
 Base size: 290X190mm

Model: WT02513
 Voltage: 230/110V
 Frequency: 50/60Hz
 Input power: 350W
 Drilling cap.: 3-16mm
 Spindle travel: 60mm
 Spindle taper: B16(JT33)
 Speed of spindle: 5(12)
 Rotary radius of table: 127mm
 Table size: 190X190mm
 Base size: 340X205mm

Model: WT02515
 Voltage: 230/110V
 Frequency: 50/60Hz
 Input power: 375(550)W
 Drilling cap.: 3-16mm
 Spindle travel: 80mm
 Spindle taper: MT2(MT2-B16)
 Speed of spindle: 16(12)
 Rotary radius of table: 165mm
 Table size: 250mm
 Base size: 420X350mm

Model: WT02514
 Voltage: 230/110V
 Frequency: 50/60Hz
 Input power: 375W
 Drilling cap.: 3-16mm(1.5-13)
 Spindle travel: 60mm
 Spindle taper: B16
 Speed of spindle: 5(12)
 Rotary radius of table: 127mm
 Table size: 250mm
 Base size: 340X205mm

Model: WT02516
 Voltage: 230/110V
 Frequency: 50/60Hz
 Input power: 375(550)W
 Drilling cap.: 5-20mm
 Spindle travel: 85mm
 Spindle taper: MT2
 Speed of spindle: 16(12)
 Rotary radius of table: 180mm
 Table size: 260X260mm
 Base size: 460X270mm(500X300mm)



Model: VG02513



Model: VG02514



Model: VG02515



Model: VG02516

BENCH DRILLING MACHINE

BENCH DRILLING MACHINE



Model: VG02517



Model: VG02518



Model: VG02519

Model: WT02517
 Voltage: 230/110V
 Frequency: 50/60Hz
 Input power: 375(550)W
 Drilling cap.: 3-16mm
 Spindle travel: 80mm
 Spindle taper: MT2(MT2-B16)
 Speed of spindle: 16(12)
 Rotary radius of table: 165mm
 Table size: 290mm
 Base size: 440X260mm

Model: WT02518
 Voltage: 230/110V
 Frequency: 50/60Hz
 Input power: 550(750)W
 Drilling cap.: 5-20mm
 Spindle travel: 80mm
 Spindle taper: MT2-822 MT3-822
 Speed of spindle: 16(12)
 Rotary radius of table: 173mm
 Table size: 260X260mm
 Base size: 460X272mm

Model: WT02519
 Voltage: 230/110V
 Frequency: 50/60Hz
 Input power: 750(1100)W
 Drilling cap.: 25mm
 Spindle travel: 80mm
 Spindle taper: MT#3
 Speed of spindle: 16
 Rotary radius of table: 167mm
 Table size: 290X290mm
 Base size: 500X300mm

Model: WT02520
 Voltage: 230/110V
 Frequency: 50/60Hz
 Input power: 550(750)W
 Drilling cap.: 5-25mm
 Spindle travel: 85mm
 Spindle taper: MT3
 Speed of spindle: 12(9)
 Rotary radius of table: 227mm
 Table size: 330X330mm
 Base size: 560X350mm

Model: WT02521
 Voltage: 230/110V
 Frequency: 50/60Hz
 Input power: 750(1100)W
 Drilling cap.: 5-32mm
 Spindle travel: 120mm
 Spindle taper: MT4
 Speed of spindle: 12(9)
 Rotary radius of table: 254mm
 Table size: 360X360mm
 Base size: 630X370mm

Model: WT02522
 Voltage: 230/110V
 Frequency: 50/60Hz
 Input power: 550(750)W
 Drilling cap.: 32mm
 Spindle travel: 120mm
 Spindle taper: MT#4
 Speed of spindle: 12
 Rotary radius of table: 254mm
 Table size: 420X480mm
 Base size: 560X450mm



Model: VG02520



Model: VG02521



Model: VG02522

BENCH DRILLING MACHINE

230V/650Hz
/13MM 250W
/16MM 450W
/16MM 550W
/20MM 550W
/20MM 750W
/32MM 1100W



BENCH DRILLING MACHINE

DRILLING CAPACITY: 1.5-13MM
VOLTAGE: 220-240V
FREQUENCY: 50-60HZ
IN PUT POWER: 250W
SPINDLE SPEED: 515-2580RPM



DRILL STAND



WOOD BAND SAW MACHINE

MODEL: VG JDD 140
6"/140MM
250W

MODEL: VG JDD 315
12"/305MM
750W



MEAT SAW

Voltage:220-240v
Frequency:50-60hz
Max cutting depth:240mm
Max cutting width:250mm
Table size:470x600mm
Sliding rang of table:265mm
Speed:4.74m/s
Blade width:15mm
Length:2085mm
Teeth:4tpi
Wheel diameter: 253mm



TABLE SAW12"

VOLTAGE:220-240V
FREQUENCY:50-60Hz
INPUT POWER:50HZ
NO LOAD SPEED:2950rpm
CUTTING ANGLE:0°-45°
MAX CUTTING CAPACITY:
50-87MM



550MM MITER SAW

MAX CUTTING HEIGHT:120MM
MAX CUTTING HEIGHT:160MM
CUTTING ANGLE CAPACITY:+45
BLADE LENGTH:550MM
BLADE WIDTH:45MM



TILE CUTTING MACHINE

Model.ZE-VG3-70A 300x25.4 1800W/
Model.ZE-VG3-570A 230MMx25.4 800W/
Model.ZE-VG2-70 250X25.4MM 1100W/
Model.ZE-VG3-400 200X25.4MM 550W



WOOD WORKING TABLE SAW

model: VG WS-5003 380V/2200W
model: VG WS-5002 230V/2200W



TILE CUTTER

Blade diameter 180X22.2X2.2mm
Rated voltage 220-240V
Rated frequency 50/60Hz
Rated input power 450W
No-load speed 2800r/min



POWER CUTTER



ELECTRIC MOTOR CONCRETE MIXER

Voltage:220-240V
Frequency:50-60Hz
Power:375W
Capacity:120L
No load speed:1380rpm



ELECTRIC MOTOR CONCRETE MIXER

Voltage: 230/110V
Frequency: 50/60Hz
No-load speed: 30rpm
Input power: 375/500W
Cap.: 180L



ELECTRIC MOTOR CONCRETE MIXER

Voltage:220-240V
Frequency:50-60Hz
Power:550W
Capacity:180L
No load speed:1380rpm

■ CUT-OFF MACHINE

MOD.VG8010B



Dics Diameter: 355mm
 Rated Voltage: 220-240V~
 Rated Frequency: 50-60Hz
 Rated Input Power: 1800W
 No-load Speed: 3800r/min

■ CUT-OFF MACHINE

MOD.VG8011B



Dics Diameter: 355mm
 Rated Voltage: 220-240V~
 Rated Frequency: 50-60Hz
 Rated Input Power: 2200W
 No-load Speed: 4000r/min

■ CUT-OFF MACHINE

MOD.VG8060



Dics Diameter: 355mm
 Rated Voltage: 220-240V~
 Rated Frequency: 50-60Hz
 Rated Input Power: 2300W
 No-load Speed: 4000r/min

■ CUT-OFF MACHINE

MOD.VG8012



Dics Diameter: 355mm
 Rated Voltage: 220-240V~
 Rated Frequency: 50-60Hz
 Rated Input Power: 2200W
 No-load Speed: 4000r/min

■ CUT-OFF MACHINE

MOD.VG8070



Dics Diameter: 355mm
 Rated Voltage: 220-240V~
 Rated Frequency: 50-60Hz
 Rated Input Power: 2300W
 No-load Speed: 4000r/min

■ CUT-OFF MACHINE

MOD.VG80400A



Dics Diameter: 400mm
 Rated Voltage: 220-240V~
 Rated Frequency: 50-60Hz
 Rated Input Power: 3000W
 No-load Speed: 3500r/min



ELECTRIC ENGRAVER

Permanently engraves on metal, wood, plastics, ceramics, leather.
 Variable speed control dial.



SIGNATURE

Diamond tip permanently engraves on any material-wood, steel, plastic, glass
 Security identification of valuables
 Rotary motion gives precise, smooth, quiet operation



**M1K-VG2-6H
 SPIRAL SAW**

Voltage:230/110V Frequency:50/60Hz
 Power Input:750W/600W
 NO-Load speed:3000-31000min
 Chuck diameter:1/8" 1/4"
 Weight:1.8Kg
 Measurement:26.5×8.5×14.5cm
 Packing size:53.5×16×28cm
 G.W/M.W:13Kg/11Kg(6set)
 20'PCS/Cowtainer:7100set



**M1K-VG2-6
 SPIRAL SAW**

Voltage:230/120V Frequency:50/60Hz
 Power Input:600W/4.85A
 NO-Load speed:31000min
 Chuck diameter:1/8" 1/4"
 Weight:1.5Kg
 Measurement:25.9×14×8.2cm
 Packing size:44.5×27.5×18cm
 G.W/M.W:13Kg/11Kg(6set)
 20'PCS/Cowtainer:7700set



**M1K-VG2-6E
 SPIRAL SAW**

Voltage:230/110V Frequency:50/60Hz
 Power Input:750W/600W
 NO-Load speed:3000-31000min
 Chuck diameter:1/8" 1/4"
 Weight:1.8Kg
 Measurement:26.5×8.5×14.5cm
 Packing size:53.5×16×28cm
 G.W/M.W:13Kg/11Kg(6set)
 20'PCS/Cowtainer:7100set





ELECTRIC SHEEP SHEAR

Complete with carry case, comb, cutter, screwdriver, oil and brush.
 Powerful 300 Watt fan cooled motor
 Speed at 3000 RPM provides 80 cutter strokes per second
 Thermal overload reset button stops motor burning out
 6 metre power supply cord
 Double insulated protected body
 Slimmer, lighter well balanced hand grip
 Optional clipping head



ROUTER MACHINE

Voltage: 220-240V
 Frequency: 50-60Hz
 Input power: 1200W
 No load speed: 11000-26000RPM
 Router: 8mm



RECIPROCATING SAW M1W-VG-210E

Voltage: 230/110V
 Frequency: 50/60Hz
 Power Input: 920W
 No-load speed: 500-2500min⁻¹
 Stroke: 29mm
 Cutting /Wood:: 210mm
 Cutting/Aluminium:: 20mm
 Cutting/Non-alloyed steel: 10mm



ELECTRIC CIRCULAR SAW

Rated voltage: 220-240V
 Frequency: 50-60hz
 Rated input power: 1300w
 No-load speed: 5000rpm
 Blade diameter: 185mm

VG 0671



ELECTRIC MINI DRILL SET

Power Input: 130Watt
 220-240V 50/60Hz
 Clamping container: 3.2mm
 No load speed: 8000-3000rpm



GRASS TRIMMER CORDLESS



N1E-VG-320 GRASS TRIMMER

Voltage: 230/110V
 Frequency: 50/60Hz
 Power Input: 400w
 NO-Load speed: 11000min
 Cutting Diameter: 320mm
 G.W/M.W: 3Kg/2.4Kg



N1E-VG-250 GRASS TRIMMER

Voltage: 230/110V
 Frequency: 50/60Hz
 Power Input: 250w
 NO-Load speed: 12000min
 Cutting Diameter: 250mm
 G.W/M.W: 3Kg/2.1Kg
 Packing size: 74 x 58 x 21cm(4set)
 20'PCS/Cowtainer: 2500set



ELECTRIC BLOWER

Rated voltage: 220-240V/50-60Hz
 Power input: 600W
 No-load speed: 3000-13000rpm
 Blowing rate: 2.8m³/min
 Including 1 pc rubber tube
 & 1 pc collection bag



ELECTRIC BLOWER

Rated voltage: 220-240V/50-60Hz
 Power input: 750W
 No-load speed: 3000-13000rpm
 Blowing rate: 3.5m³/min
 collecting dust cap: 2L



ELECTRIC BLOWER

ALUM. DARK GREEN BODY
 2"/150W
 2.5"/260W
 3" 4"



GRASS TRIMMER



VGJ45 CHAIN SAW



DISPLACEMENT: 45CC
 GASOLINE AND OIL MIXED RATIO: 25:1
 STARTING SYSTEM: RECOIL STARTER
 ENGINE TYPE: SINGLE CYLINDER,
 2-STROKE, FORCED AIR COOLING
 RATED SPEED: 7000RPM
 GUIDE BAR SIZE: 455MM
 MAX. TORQUE: 2.0N.M

FLUX WIRE WELDER

Include: helmet, glass, hammer brush, tip, wrench, 0.8mm flux wire

FEED WIRE AUTOMATICALLY
DC CURRENT OUTPUT
SINGLE PHASE POWER
AUTO TEMPERATURE
PROTECTION



EASYMIG100

80 AMP

Automatic Temperature Protection
Applied for: Flux Core Wire(0.8~0.9mm)
Rated Input Voltage:220~240V
Frequency:50/60Hz
Voltage at no Load:31V
Range of Current: 50-80A
Rated Duty Cycle:90A@10%
Input Capacity:2KVA
Insulation Class: F
Fuse:12A



100 AMP

Automatic Temperature Protection
Applied for: Flux Core Wire(0.8~0.9mm)
and solid wire(0.6~0.8)
Rated Input Voltage:220~240V
Frequency:50/60Hz
Voltage at no Load:30V
Range of Current: 25-100A
Rated Duty Cycle:75A@20%
Input Capacity:2KVA
Insulation Class: F
Fuse:12A

DUALMIG130



DUALMIG131

Automatic Temperature Protection
Applied for: Flux Core Wire(0.8~0.9mm)
and solid wire(0.6~0.8)
Rated Input Voltage:220~240V
Frequency:50/60Hz
Voltage at no Load:28V
Range of Current: 25-85A
Rated Duty Cycle:75A@20%
Input Capacity:2KVA
Insulation Class: F
Fuse:12A

85 AMP



EASYMIG105

Automatic Temperature Protection
Applied for: Flux Core Wire(0.8~0.9mm)
Rated Input Voltage:220~240V
Frequency:50/60Hz
Voltage at no Load:33V
Range of Current: 25-105A
Rated Duty Cycle:90A@10%
Input Capacity:2KVA
Insulation Class: F
Fuse:12A

105 AMP



DUALMIG135

Automatic Temperature Protection
Applied for: Flux Core Wire(0.8~0.9mm)
and solid wire(0.6~0.8)
Rated Input Voltage:220~240V
Frequency:50/60Hz
Voltage at no Load:28V
Range of Current: 25-135A
Rated Duty Cycle:90A@20%
Input Capacity:3KVA
Insulation Class: F
Fuse:15A

135 AMP

INVERTER DC TIG WELDING MACHINE WIDELY USED, SUIT FOR TIG WELDING.

Single-phase, portable, fan-cooled, thermostatic protection.
Adopt with advanced IGBT inverter technology.
Stepless current adjustment.

IGBT inverter technology
power supply: 1X230V 50/60Hz 3.5KVA
no load voltage: 70V
welding current range: 5-160A
duty cycle:35%160A, 60%125A, 100%100A.
Gas post flow time: 0-10s.



PT160 160A

Include: 2m welding cable+300A clamp, 4mSR-17TIG torch, 5m Gas hose, HF arc start for TIG.

Single-phase, portable, fan-cooled, thermostatic protection.
Adopt with advanced IGBT inverter technology.
Stepless current adjustment.

IGBT inverter technology
power supply: 1X220-240V 50/60Hz 5KVA
no load voltage: 70V
welding current range: 5-200A
duty cycle:35%200A, 60%160A, 100%125A.
Gas post flow time: 0-10s.



PT200 200A

Include: 2m welding cable+300A clamp, 4mSR-26TIG torch, 5m Gas hose, HF arc start for TIG.

INVERTER PULSE TIG WELDING MACHINE WIDELY USED, SUIT FOR TIG/MMA WELDING.

Single-phase, portable, fan-cooled, thermostatic protection.
Adopt with advanced IGBT inverter technology.
Stepless current adjustment.

IGBT inverter technology
power supply: 1X220-240V 50/60Hz 5KVA
no load voltage: 70V
welding current range: 5-200A and digital display.
duty cycle:35%200A, 60%160A, 100%125A.
2T/4T at TIG mode.
DC PULSE TIG/DC TIG/MMA.
Current Up-slope and down-slop time: 0-5s.
Gas post flow time: 5s/10s.
Can be connecting with foot controller.
Pulse frequency:0.5-25Hz.



ITIG160 160A

Include: 3m welding cable+300A holder,3m welding cable+300Aclamp, 4mSR-17TIG torch, 5m Gas hose, HF arc start for TIG.

Single-phase, portable, fan-cooled, thermostatic protection.
Adopt with advanced IGBT inverter technology.
Stepless current adjustment.

IGBT inverter technology
power supply: 1X220-240V 50/60Hz 5KVA
no load voltage: 70V
welding current range: 5-200A and digital display.
duty cycle:35%200A, 60%160A, 100%125A.
2T/4T at TIG mode.
DC PULSE TIG/DC TIG/MMA.
Current Up-slope and down-slop time: 0-5s.
Gas post flow time: 5s/10s.
Can be connecting with foot controller.
Pulse frequency:0.5-25Hz.



ITIG200

Include: 3m welding cable+300A holder,3m welding cable+300Aclamp, 4mSR-26TIG torch, 5m Gas hose, HF arc start for TIG.



**PROFESSIONAL
WELDING MACHINE
BX1-200-2
AC-ARC WELDER**



WELDING MACHINE

BX1-130C2	BX1-160C2	BX1-180C2	BX1-250C2	BX1-200C2
230V	230V	230-400V	230-400V	230-400V
48V	48V	48V	48V	48V
55-130A	55-160A	60-180A	65-250A	60-200A
10%	10%	10%	10%	10%
6.4KW	8KW	9.6KW	14KW	11.2KW
H	H	H	H	H
2-3.2MM	2-4MM	2-4MM	2.5-5MM	2-4MM
15KG	17.5KG	21KG	25.5KG	23KG



**TG131
PVC WELDING DEVICE KIT**

Specified voltage: 220V-240V 50/60HZ
rated power: 800W
job temperature: 260°C ±10°C
the bonding tool at random: 20-63
the accommodation: PE, PB-C, PP-R



**TG151
PVC WELDING DEVICE KIT**

Specified voltage: 220V-240V 50/60HZ
rated power: 800W
job temperature: 260°C ±10°C
the bonding tool at random: 20-63cm
the accommodation: PE, PB-C, PP-R



**TG170
PVC WELDING DEVICE KIT**

Specified voltage: 220V-240V 50/60HZ
rated power: 700W/1500W
job temperature: 260°C ±10°C
the bonding tool at random: 20-63
the accommodation: PE, PB-C, PP-R



**TG150
PVC WELDING DEVICE KIT**

Specified voltage: 220V-240V 50/60HZ
rated power: 600W
job temperature: 260°C ±10°C
the bonding tool at random: 20-32
the accommodation: PE, PB-C, PP-R



**2000W
DOUBLE INSULATOR
WELDER DEVICE KIT
DOUBLE VOLTAGE PIPE**
Specified voltage: 220V-240V 50/60HZ
Rated power: 1000W/2000W
Job temperature: 260°C ±10°C
The bonding tool at random: 20-63mm
The accommodation: PE, PB-C, PP-R



AC WELDER



Can With Accessories

BX6-160B (160A) Stainless steel

Single-phase, portable fan-cooled, high duty cycle.
Professional welder, step current adjustment.
Easy to install.
Compact size allows for easy storage and handling.
Suitable for various electrodes.

Rated input voltage	220-240V
No load voltage	48V
Current range	55-160A
Rated duty	20%
Input capacity	8.8KW
Class of insulation	F
Usable electrodes	2-3.2mm



BX6-180B (180A) Stainless steel

Single-phase, portable fan-cooled, high duty cycle.
Professional welder, step current adjustment.
Easy to install.
Compact size allows for easy storage and handling.
Suitable for various electrodes.

Rated input voltage	220-240V
No load voltage	48V
Current range	55-180A
Rated duty	20%
Input capacity	10KW
Class of insulation	F
Usable electrodes	2-3.2mm





BX6-200B (200A) Stainless steel

Single-phase, portable fan-cooled, high duty cycle.
Professional welder, step current adjustment.
Easy to install.
Compact size allows for easy storage and handling.
Suitable for various electrodes.

Rated input voltage	220-240V
No-load voltage	40V
Current range	60-200A
Rated duty	20%
Input capacity	11KW
Class of insulation	F
Usable electrodes	2-4mm



BX6-250B (250A) Stainless steel

Single-phase, portable fan-cooled, high duty cycle.
Professional welder, step current adjustment.
Easy to install.
Compact size allows for easy storage and handling.
Suitable for various electrodes.

Rated input voltage	220-240V/400V
No-load voltage	40V
Current range	60-250A
Rated duty	20%
Input capacity	13KW
Class of insulation	F
Usable electrodes	2-4mm



BX6-300B (300A) Stainless steel

Single-phase, portable fan-cooled, high duty cycle.
Professional welder, step current adjustment.
Easy to install.
Compact size allows for easy storage and handling.
Suitable for various electrodes.

Rated input voltage	220-240V/400V
No-load voltage	50V
Current range	65-300A
Rated duty	20%
Input capacity	18KW
Class of insulation	F
Usable electrodes	2.5-4mm



BX6-400B (400A) Stainless steel

Single-phase, portable fan-cooled, high duty cycle.
Professional welder, step current adjustment.
Easy to install.
Compact size allows for easy storage and handling.
Suitable for various electrodes.

Rated input voltage	220-240V/400V
No-load voltage	50V
Current range	75-400A
Rated duty	20%
Input capacity	28KW
Class of insulation	F
Usable electrodes	2.5-4mm



SB502-2 HIGH PRESSURE WASHER

220-240V 50/60Hz 1600W IPX5
Rated pressure: 7MPa Flow:5L/min
Permissible pressure: 10.5 Mpa
Water temp. Max.: 60°C



3m hose
Soap bottle
Gun
Extension lance
Lance with adjustable nozzle



SI604-2 HIGH PRESSURE WASHER

220-240V 50/60Hz 2400W IPX5
Rated pressure: 12MPa Flow:6L/min
Permissible pressure: 18 Mpa
Water temp. Max.: 60°C



6m hose
Gun
Hose wheel
Inner soap bottle
Lance with adjustable nozzle
Telescopic Al alloy handle pole



5m hose
Gun
Inner soap bottle
Lance with adjustable nozzle
Telescopic Al alloy handle pole

HIGH PRESSURE WASHER
220-240V 50/60Hz 2200W IPX5
Rated pressure: 12MPa Flow:5.5L/min
Permissible pressure: 16 Mpa
Water temp. Max.: 60°C



SB603-2

XM-2062
• MODEL



ELECTRIC HIGH PRESSURE WASHER

MODEL	Neutral Pressure/Water	White	Power	Motor Type	Flow	Max. pressure (bar)	Weight	Max. temperature (°C)	Oil per container (liters per container)
XM-2062	93	160	220-240 V/50-60Hz	1000	Induction	6.5	10	150/150	90 L/100 L/100 L

XM-2071
• MODEL



ELECTRIC HIGH PRESSURE WASHER

MODEL	Neutral Pressure/Water	White	Power	Motor Type	Flow	Max. pressure (bar)	Weight	Max. temperature (°C)	Oil per container (liters per container)
XM-2071-1	116	200	220-240 V/50-60Hz	2000	Induction	6.5	10	150/150	90 L/100 L/100 L
XM-2071-2	134	230	220-240 V/50-60Hz	2600	Induction	7	10	150/150	90 L/100 L/100 L
XM-2071-3	154	270	220-240 V/50-60Hz	3000	Induction	7.5	10	150/150	90 L/100 L/100 L
XM-2071	134	230	100-120 V/60 Hz	1400	Induction	6.5	10	150/150	90 L/100 L/100 L



VG-2072-3
ELECTRIC HIGH PRESSURE WASHER

Working pressure: 140 bar
Max pressure: 210 bar
Voltage: 220-240V 50-60Hz
Power: 3000W
Flow: 7.5 L/min

HIGH PRESSURE WASHER

Adjustable spray nozzle varies cleaning pattern and water pressure.
-Spray wand for all general cleaning needs such as: cats, bosts, decks, siding, etc



Working pressure: 90 bar
Max pressure: 160 bar
Voltage: 220-240V 50-60Hz
Power: 2000W
Flow: 6 L/min

ELECTRIC HIGH PRESSURE WASHER

Working pressure: 140 bar
Max pressure: 210 bar
Voltage: 220-240V 50-60Hz
Power: 3000W
Flow: 7.5 L/min



HOSE REEL & WATER SPRINKLER



HIGH PRESSURE WASHER



HIGH PRESSURE WASHER

XM-888

- Fuel: diesel oil fuel consumption: 2Kg/H
- Oil tank capacity: 18L
- Outlet water temperature: Ambient-80°C
- Detergent tank capacity: 8L
- Input voltage: AC220-240V, 50Hz
- Output power: 2500W
- Outlet water pressure: 90Bar, max: 150Bar
- Water consumption: 6L/Min

HIGH PRESSURE WASHER

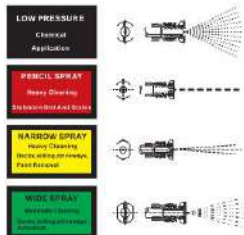

GASOLINE HIGH PRESSURE WASHER

15.4MPA/2200PSI 7.0LPM/1.8GPM
5.5HP OHV 4-STROKE ENGINE
45 C/140 F MAX. INLET TEMPERATURE
10 METER LONG HOSE
KGS 59X52X81CM

GASOLINE HIGH PRESSURE WASHER

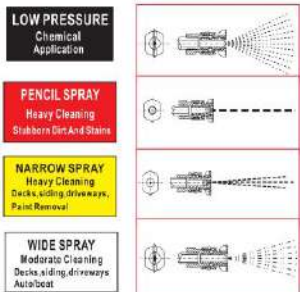

- 13MPA/1800PSI, 6LPM/1.6GPM
- 2.4HP OHV 4-STROKE ENGINE
- 60°C/140°F MAX. INLET TEMPERATURE
- 6 METER LONG HOSE
- 30KGS 50X40X55CM

AIR COMPRESSOR VG02561

POWER: HP 1
KW 0.75
SPEED: 2850rpm/3450rpm
MAX PRESSURE: 8 bar
116psi
TANK VOLUME: LITER 50/GALLON 12.5



GASOLINE GENERATOR

AC circuit breaker
Fuel tank capacity: 4L
2 stroke, reed valve
Air - cooled, single cylinder
Displacement: 63CC



GASOLINE WATER PUMP MODEL: GF-50X



Connection pimeasion: 50mm
Flow: 30m³/h
Suction height: 7m
Lift height: 30m



GASOLINE POWER SPRAYER SET SIZE: 5.5HP



PERIPHERAL PUMP

0.5HP PKM60
Voltage: 220-240v/50-60hz
Power: 1/2 hp
Max. flow: 35l/min
Max. head: 354m



POWER SPRAYER VG3WZ-22

SPRAYING	IRRIGATION
800-1000	Revolution(R.P.M) 1200-1400
16.5-20.5	Suction(L/min) 25-29
15-35	pressure(Kg/cm ²) 10
2-4	power(HP/KW) 2-4



STEAM CLEANER

Rated voltage: 220-240V
Rated frequency: 50/60Hz
Rated power: 1800W
Steam temperature: 100-130°C
Emission pressure: 4 BAR
Water tank capacity: 2L



CLEANING MACHINE



VACUUM SWEEPER



**VGWT04
GASOLINE GARDEN TILLER**
(2FORWARD/1REVERSER-MID TINE)
G.W.:88KGS
N.W.:73KGS
MEAS.:830×380×780MM



**VGWT02
GASOLINE GARDEN TILLER**
(1FORWARD/1REVERSER-MID TINE)
G.W.:86KGS
N.W.:76KGS
MEAS.:1070×510×480MM



**30" GASOLINE
RIDING LAWN MOWER**
MODEL:VGCJ30G
15HP ENGINE
CUTTING HEIGHT:20-90MM
(WITH BLADES)

AUTOMATIC VOLTAGE REGULATOR (MVR)



MODEL NO: MVR-500VA
Input: 140-260V~ 50Hz
Output:220V~ 50Hz
Power:500VA
Technology: Analog Circuit +
Meter Display + Servo Motor
High Voltage Protection
Low Voltage Protection
Overload Protection
High Temperature Protection



MODEL NO: MVR-1500VA
Input: 150-270V~ 50Hz
Output:230V~ 50Hz
Power:1500VA
Technology: Analog Circuit +
Meter Display + Servo Motor
High Voltage Protection
Low Voltage Protection
Overload Protection
High Temperature Protection



MODEL NO: MVR-3000VA
Input: 150-270V~ 50Hz
Output:230V~ 50Hz
Power:3000VA
Technology: Digital Circuit +Meter
Display + Servo Motor
High Voltage Protection
Low Voltage Protection
Overload Protection
High Temperature Protection



MODEL NO: MVR-5000VA
Input: 150-270V~ 50Hz
Output:230V~ 50Hz
Power:5000VA
Technology: Digital Circuit +Meter
Display + Servo Motor
High Voltage Protection
Low Voltage Protection
Overload Protection
High Temperature Protection

AUTOMATIC VOLTAGE REGULATOR(SVR)



MODEL NO: SVR-500VA
Input: 140-260V~ 50/60Hz
Output:220V~ 50/60Hz
Power:500VA
Technology: Analog circuit+
meter display
High Voltage Protection
Low Voltage Protection
Overload Protection
High Temperature Protection



MODEL NO: SVR-1000VA
Input: 150-270V~ 50Hz
Output:230V~ 50Hz
Power:1000VA
Technology: Analog circuit+
meter display
High Voltage Protection
Low Voltage Protection
Overload Protection
High Temperature Protection



MODEL NO: SVR-1500VA
Input: 140-260V~ 50Hz
Output:220V~ 50Hz
Power:1500VA
Technology: Meter display
+ Annular transformer
High Voltage Protection
Low Voltage Protection
Overload Protection
High Temperature Protection



MODEL NO: SVR-2000VA
Input: 140-260V~ 50Hz
Output:220V~ 50Hz
Power:2000VA
Technology: Meter display
+ Annular transformer
High Voltage Protection
Low Voltage Protection
Overload Protection
High Temperature Protection



MODEL NO: SVR-3000VA
Input: 150-270V~ 50Hz
Output:230V~ 50Hz
Power:3000VA
Technology: Analog circuit+
meter display
High Voltage Protection
Low Voltage Protection
Overload Protection
High Temperature Protection



MODEL NO: SVR-5000VA
Input: 150-270V~ 50Hz
Output:230V~ 50Hz
Power:5000VA
Technology: Analog circuit+
meter display
High Voltage Protection
Low Voltage Protection
Overload Protection
High Temperature Protection

AUTOMATIC VOLTAGE REGULATOR(TVR)



MODEL NO: TVR-8000VA
Input: 150-270V~ 50/60Hz
Output:230V~ 50/60Hz
Power:8000VA
Technology: Meter Display
+ C.R.G.O Transformer
High Voltage Protection
Low Voltage Protection
Overload Protection
High Temperature Protection



MODEL NO: TVR-10KVA
Input: 150-270V~ 50/60Hz
Output:230V~ 50/60Hz
Power:10000VA
Technology: Meter Display
+ C.R.G.O Transformer
High Voltage Protection
Low Voltage Protection
Overload Protection
High Temperature Protection

AUTOMATIC VOLTAGE REGULATOR(IDR)



MODEL NO: IDR-8000VA
Input: 140-260V~ 50/60Hz
Output:220V~ 50/60Hz
Power:8000VA
Technology: Digital Circuit+
Digital LED Display+Servo Motor
High Voltage Protection
Low Voltage Protection
Overload Protection
High Temperature Protection



MODEL NO: IDR-10KVA
Input: 140-260V~ 50Hz
Output:220V~ 50Hz
Power:10000VA
Technology: Digital Circuit+
Digital LED Display+Servo Motor
High Voltage Protection
Low Voltage Protection
Overload Protection
High Temperature Protection

**500W
POWER INVERTER**

Input voltage:DC 12V
Output voltage:AC 220V
Continuous power:500W
Peak power:1000W
USB port:5V 500mA (optional)



**800W
POWER INVERTER**

Input voltage:DC 12V
Output voltage:AC 220V
Continuous power:800W
Peak power:1600W
Charging max current:10A



**500W
POWER INVERTER**

Input voltage:DC 12V
Output voltage:AC 220V
Continuous power:500W
Peak power:1000W
Charging max current:10A



**800W
POWER INVERTER**

Input voltage:DC 12V
Output voltage:AC 220V
Continuous power:800W
Peak power:1600W
USB port:5V 500mA (optional)



**800W
POWER INVERTER**

Input voltage:DC 12V
Output voltage:AC 220V
Continuous power:800W
Peak power:1600W
Charging max current:10A



**1250W
POWER INVERTER**

Input voltage:DC 12V
Output voltage:AC 220V
Continuous power:1250W
Peak power:2500W
USB port:5V 500mA (optional)



**1500W
POWER INVERTER**

Input voltage:DC 12V
Output voltage:AC 220V
Continuous power:1500W
Peak power:3000W
Charging max current:10A



**1250W
POWER INVERTER**

Input voltage:DC 12V
Output voltage:AC 220V
Continuous power:1250W
Peak power:2500W
USB port:5V 500mA (optional)



**800W
POWER INVERTER**

This Device Converts Dc 12V to AC 220-240V
Frequency:50Hz±5%
Output Waveform: Modified sine wave
Low Battery-Voltage Alarm(volts): 10.5±0.5V



**1250W
POWER INVERTER**

This Device Converts Dc 12V to AC 220-240V
Frequency:50Hz±5%
Output Waveform: Modified sine wave
Low Battery-Voltage Alarm(volts): 10.5±0.5V



**1500W
POWER INVERTER**

This Device Converts Dc 12V to AC 240V
Frequency:50Hz±5%
Output Waveform: Modified sine wave
Low Battery-Voltage Alarm(volts): 10.5±0.5V



**2000W
POWER INVERTER**

This Device Converts Dc 12V to AC 240V
Frequency:50Hz±5%
Output Waveform: Modified sine wave
Low Battery-Voltage Alarm(volts): 10.5±0.5V



**2500W
POWER INVERTER**

This Device Converts Dc 12V to AC 220-240V
Frequency:50Hz±5%
Output Waveform: Modified sine wave
Low Battery-Voltage Alarm(volts): 10.5±0.5V



**2500W
POWER INVERTER**

This Device Converts Dc 12V to AC 240V
Frequency:50Hz±5%
Output Waveform: Modified sine wave
Low Battery-Voltage Alarm(volts): 10.5±0.5V



**3000W
POWER INVERTER**

This Device Converts Dc 12V to AC 220-240V
Frequency:50Hz±5%
Output Waveform: Modified sine wave
Low Battery-Voltage Alarm(volts): 10.5±0.5V



**3500W
POWER INVERTER**

This Device Converts Dc 12V to AC 240V
Frequency:50Hz±5%
Output Waveform: Modified sine wave
Low Battery-Voltage Alarm(volts): 10.5±0.5V



**CB-16S
BATTERY CHARGER**

RATED INPUT VOLTAGE: 220-240V
 CURRENT RANGE: 15A
 RATED POWER: 400W
 RATED CAPACITY: 0.4KVA
 CLASS OF INSULATION: H
 CHARGING VOLTAGE: 12/24V
 CHARGING CURRENT: 7.5A
 GROSS WEIGHT: 7KG

**CB-12M
BATTERY CHARGER**

RATED INPUT VOLTAGE	220-240V
CURRENT RANGE	12A
RATED POWER	350W
RATED CAPACITY	0.5KVA
CLASS OF INSULATION	H
CHARGING VOLTAGE	6/12V
CHARGING CURRENT	48A
GROSS WEIGHT	6KG

**CB-30S
BATTERY CHARGER**

RATED INPUT VOLTAGE: 230v
 CHARGING VOLTAGE: 12/24V
 CURRENT RATED: 16/20A
 START CURRENT: 16/20A
 RATED POWER: 480W
 RATED CAPACITY: 0.58KVA
 CLASS OF INSULATION: H
 WEIGHT: 10.6KG

**BATTERY CHARGER
FLASH-50**

Single phase input, 12V/24V
 voltage output.
 Self-protected against
 overloads or polarity reversal .
 Equipped with selector for
 normal/boost charging.
 Suitable for charging for lead-acid
 batteries.
 Ability of charging and starting for kinds of
 motorcycles, cars, vans, light trucks, etc.

**CB-12S
BATTERY CHARGER**

RATED INPUT VOLTAGE: 220-240V
 CURRENT RANGE: 3-6A
 RATED POWER: 20-60Ah
 RATED CAPACITY: 86W
 CLASS OF INSULATION: H
 CHARGING VOLTAGE: 12/24V
 CHARGING CURRENT: 6A/3A
 GROSS WEIGHT: 4.2KG

**CB-20S
BATTERY CHARGER**

RATED INPUT VOLTAGE: 230V
 CHARGING VOLTAGE: 12/24V
 CURRENT RATED: 9/4A
 START CURRENT: 12/16A
 RATED POWER: 120W
 RATED CAPACITY: 0.26KVA
 CLASS OF INSULATION: H
 WEIGHT: 6.8KG

**CB-50S
BATTERY CHARGER**

RATED INPUT VOLTAGE: 220~240V
 CHARGING VOLTAGE: 12/24V
 CURRENT RATED: 25A
 START CURRENT: 30A
 RATED POWER: 600W
 RATED CAPACITY: 0.88KVA
 CLASS OF INSULATION: H
 WEIGHT: 15KG

**CD-220
BATTERY CHARGER**

RATED INPUT VOLTAGE: 220-240V
 RATED CURRENT: 16A
 RATED CAPACITY: 0.46/3.6KW
 CHARGING VOLTAGE: 12V/24V
 START CURRENT: 130A
 CLASS OF INSULATION: H
 WEIGHT: 14KG

**CD-320
BATTERY CHARGER**

RATED INPUT VOLTAGE: 220-240V
 RATED CURRENT: 20A
 RATED CAPACITY: 0.55/6.6KW
 CHARGING VOLTAGE: 12V/24V
 START CURRENT: 180A
 CLASS OF INSULATION: H
 WEIGHT: 15.5KG

**CD-420
BATTERY CHARGER**

RATED INPUT VOLTAGE: 220-240V
 RATED CURRENT: 25A
 RATED CAPACITY: 0.75/8KW
 CHARGING VOLTAGE: 12V/24V
 START CURRENT: 250A
 CLASS OF INSULATION: H
 WEIGHT: 17.5KG

**CD-520
BATTERY CHARGER**

RATED INPUT VOLTAGE: 220-240V
 RATED CURRENT: 24/30a
 RATED CAPACITY: 0.95/10KW
 CHARGING VOLTAGE: 12V/24V
 START CURRENT: 300A
 CLASS OF INSULATION: H
 WEIGHT: 26KG

**CD-620
BATTERY CHARGER**

RATED INPUT VOLTAGE: 220~240V
 RATED CURRENT: 27/35A
 RATED CAPACITY: 1.0/10KW
 CHARGING VOLTAGE: 12V/24V
 START CURRENT: 350A
 CLASS OF INSULATION: H
 WEIGHT: 28KG

BATTERY CHARGER

Single phase input, special for charging
 Acid-lead batteries with 12/24V Volts.
 With self-protection against over-loads and
 polarity reversal .
 Nice appearance with full plastic front casing.
 Suitable for many kinds of cars, motorcars, vans,
 light trucks, heavy duty trucks, tractors, ships, etc.



SMS

PROFESSIONAL POWER TOOLS
SECTION SMS

ANGLE GRINDER
 IMPACT DRILL
 ROTARY HAMMER
 ROUTER MACHINE
 BENCH GRINDER
 HOT AIR GUN

ANGLE GRINDER S1M-BQ-115C

220/240V~50/60Hz 11000min⁻¹

900W Ø 115mm

ANGLE GRINDER HAG 3049

220/240V~50/60Hz 11000min⁻¹

1010W Ø 115mm

ANGLE GRINDER R0144

220/240V~50/60Hz 3000-10500rpm

1150W Ø 125mm

ANGLE GRINDER S1M-KZ21-180

220/240V~50/60Hz 7500min⁻¹

2100W Ø 180mm

ANGLE GRINDER S1M-KM₅-230

220/240V~50/60Hz 6000min⁻¹

2350W Ø 230mm



IMPACT DRILL Z1J-13
 220/240V~50/60Hz 0-3000min⁻¹
 710W 13mm



IMPACT DRILL CX-1D216
 220/240V~50/60Hz 0-800/0-2000min⁻¹
 1200W 16mm



ROTARY HAMMER DS90526AD
 220/240V~50/60Hz 800W
 0-700min⁻¹ 26mm



ROTARY HAMMER HAM02V
 220/240V~50/60Hz 1050W
 0-850min⁻¹ 32mm



ROTARY HAMMER R0514
 220/240V~50/60Hz 1050W
 550min⁻¹ 38mm



HOT AIR GUN HG1650
 220/240V~50/60Hz 2000W
 Temperature I: 60°C
 Temperature II: 60°C-550°C



CIRCULAR SAW CDY185D
 220/240V~50/60Hz 5000min⁻¹
 1200W 185mm



8" BENCH GRINDER MD3220N
 220/240V~50/60Hz 2950min⁻¹
 300W 200mm



6" BENCH GRINDER MD3215DM
 220/240V~50/60Hz 2950min⁻¹
 180W 150mm



ROUTER MACHINE M1R-KZ3-8
 220/240V~50/60Hz 11500-34000min⁻¹
 1200W 8mm





SECTION VIM

- ANGLE GRINDER
- IMPACT DRILL
- ROTARY HAMMER
- ROUTER MACHINE
- DRILL PRESS
- BENCH GRINDER



ANGLE GRINDER VIM115

Disc diameter 115mm
 Rated voltage 220-240V
 Rated frequency 50/60Hz
 Rated input power 800W
 No-load speed 11000/min



ANGLE GRINDER VIM125A

Disc diameter 125mm
 Rated voltage 220-240V
 Rated frequency 50/60Hz
 Rated input power 1200W
 No-load speed 45000-10000/min



ANGLE GRINDER VIM180

Disc diameter 180mm
 Rated voltage 220-240V
 Rated frequency 50/60Hz
 Rated input power 2200W
 No-load speed 8500/min



ANGLE GRINDER VIM230A

Disc diameter 230mm
 Rated voltage 220-240V
 Rated frequency 50/60Hz
 Rated input power 2350W
 No-load speed 6000/min



ANGLE GRINDER VIM230

Disc diameter 230mm
 Rated voltage 220-240V
 Rated frequency 50/60Hz
 Rated input power 2200W
 No-load speed 6300/min



PROFESSIONAL QUALITY

IMPACT DRILL



VIM13A

Drill capacity 13mm
 Voltage 220-240V
 Frequency 50/60Hz
 Input power 850W
 No-load speed 0-2800/min

IMPACT DRILL



VIM13

Drill capacity 13mm
 Voltage 220-240V
 Frequency 50/60Hz
 Input power 710W
 No-load speed 0-3000/min

IMPACT DRILL



VIM13B

Drill capacity 13mm
 Voltage 220-240V
 Frequency 50/60Hz
 Input power 1100W
 No-load speed 0-1000/min / 0-3000/min

ELECTRIC SCREWDRIVER

VIM-SD



Drill capacity 10mm
 Voltage 220-240V
 Frequency 50/60Hz
 Input power 240W
 No-load speed 0-800/min

24MM ROTARY HAMMER



VIM24R

Voltage 220-240V
 Frequency 50/60Hz
 Input power 650W
 No-load speed 0-1200/min

26MM ROTARY HAMMER

VIM26H



Voltage 220-240V
 Frequency 50/60Hz
 Input power 900W
 No-load speed 780/min

PROFESSIONAL QUALITY



32MM ROTARY HAMMER

VIM32

Voltage 220-240V
 Frequency 50/60Hz
 Input power 1200W
 No-load speed 800/min
 Impact rate 4000rpm



38MM ROTARY HAMMER

VIM38

Voltage 220-240V
 Frequency 50/60Hz
 Input power 1200W
 No-load speed 500/min
 Impact rate 3200rpm

CORDLESS DRILL



VIM18V

Drill capacity 10mm
 Voltage 18V
 No-load speed 0-580/min
 3-5 Hr charge time
 15+1 torque setting



HEAT GUN

VIMHG



Voltage 220-240V
 Frequency 50/60Hz
 Input power 1200W
 Air temperature 480/580°C/cooling fan
 Air volume 300/500/500L/MIN

AIR BLOWER

VIM-AB



Blowing rate 2.8m³/min
 Rated voltage 220-240V
 Rated frequency 50/60Hz
 Rated input power 600W
 No-load speed 3000-13000/min



PROFESSIONAL QUALITY



DRILL PRESS

DRILLING CAPACITY: 13MM
 VOLT/FREQ: 220-240V 50/60HZ
 INPUT POWER: 350W
 SPINDLE STROKE: 50MM
 SPINDLE SPEED: 580-2650RPM

VM-DP13



DRILL PRESS

DRILLING CAPACITY: 16MM
 VOLT/FREQ: 220-240V 50/60HZ
 INPUT POWER: 500W
 SPINDLE STROKE: 60MM
 SPINDLE SPEED: 425-2545RPM

VM-DP16



Voltage 220-240V
 Frequency 50/60Hz
 Input power 150W
 No-load speed 2950/min
 Diameter 125mm

VM-BG125

BENCH GRINDER



Voltage 220-240V
 Frequency 50/60Hz
 Input power 200W
 No-load speed 2950/min
 Diameter 150mm

VM-BG150

BENCH GRINDER



Voltage 220-240V
 Frequency 50/60Hz
 Input power 350W
 No-load speed 2950/min
 Diameter 200mm

VM-BG200

BENCH GRINDER

CUT-OFF MACHINE



VIM355

Voltage 220-240V
 Frequency 50/60Hz
 Input power 2200W
 No-load speed 3800/min
 Diameter 355mm

PROFESSIONAL QUALITY



80MM JIG SAW

VIM80J

Cutting wood 80mm
 Rated voltage 220-240V
 Rated frequency 50/60Hz
 Rated input power 800W
 No-load speed 0-3000/min



VIM8R ELECTRIC ROUTER

Voltage 220-240V
 Frequency 50/60Hz
 Input power 1200W
 No-load speed 11500-34000/min
 Diameter 8mm



ELECTRIC PLANER

Max planing 82X3mm
 Rated voltage 220-240V
 Rated frequency 50/60Hz
 Rated input power 850W
 No-load speed 16000/min

VIM823



PORTABLE GASOLINE GENERATOR

Frequency: 50HZ
 Rated power: 650W
 Rated voltage: 230V
 Direct Current: 12V
 Fuel: pre-mixed oil-gasoline.

VIM1000GS



VM-0615A

STEAM CLEANER

INPUT POWER: 1500W
 VOLTAGE: 220-240V
 FREQUENCY: 50/60HZ
 MAX VOLUME: 0.6L/MIN
 MAX PRESSURE: 3.5BAR



STONE CUTTING MACHINE

Model: 800MM x 12"
 Model: 1000MM x 14"
 Model: 1200MM x 14"
 Model: 1500MM x 14"



VIM255

Voltage: 220-240V
 Frequency: 50/60Hz
 Input power: 2100W
 No-load speed: 4500r/min
 Cutting wheel diameter: 255mm
 Safety cover guard

255MM MITER SAW



SECTION LION

- DRILL
- ANGLE GRINDER
- CUT-OFF MACHINE
- BENCH GRINDER
- HAND BLOWER



SECTION LION



PERCUSSION-DRILL

LID 13
220-240V
50-60Hz
ELECTRIC HAMMER
1200WATT 13MM
2200/2800RPM



ANGLE GRINDER

220-240V
50-60Hz
LAG 100/LAG 115
700WATT 100/115MM 11000RPM



ANGLE GRINDER

220-240V
50-60Hz
LAG 230
1800WATT 230MM 6500RPM



FINISHING SANDER
LSD 170

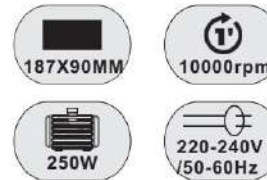

CUT-OFF MACHINE
LCM 355

2200WATT 355MM 3800RPM





CIRCULAR SAW

LCS 180

220-230V
50-60HZ
1100WATT
185MM
24000RPM



CIRCULAR SAW

LCS 235

220-240V
50-60HZ
2000WATT
235MM
4200RPM



**HAND BLOWER
LASHB-530B**

220-240V
50-60HZ
520WATT



**HAND BLOWER
LASHB-530B**

110V
53/30Hz
520WATT



JIG SAW

LJS 60

220-240V
50-60Hz

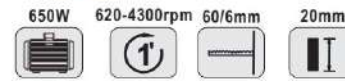

JIG SAW

LJS 55

220-240V
50-60Hz



BENCH GRINDER 5"

220-240V / 50-60Hz 2950/3450RPM
150 Watt Ø125X16XØ12.7MM



BENCH GRINDER 6"

220-240V / 50-60Hz 2950/3450RPM
250W Ø150X16XØ12.7MM



BENCH GRINDER 8"

220-240V / 50-60Hz 2950/3450RPM
350W Ø200X16XØ12.7MM

CRASHPROOF PACKAGING



PROFESSIONAL PRODUCTS

- ANGLE GRINDER
- IMPACT DRILL
- POLISHER
- JIG SAW
- MARBLE CUTTER

INDUSTRY VIGEX



**300Watt
ELECTRIC DRILL**

Input Power: 300w
NO-load speed: 0-2600r/min
Voltage: 220-240v
Frequency: 50Hz
Max drilling diameter: 6mm

VGN6



**500Watt
ELECTRIC DRILL**

Input Power: 500w
NO-load speed: 0-2800r/min
Voltage: 220-240v
Frequency: 50Hz
Max drilling diameter: 10mm

VGN10

Variable speed



**850Watt
IMPACT DRILL**

Input Power: 850w
NO-load speed: 0-2800r/min
Voltage: 220-240v
Frequency: 50Hz
Diameter: 1.5-13mm
Impact rate: 44800r/min



VGN13AK



**1050Watt
IMPACT DRILL**

Voltage: 220-240v
Frequency: 50Hz
Power input: 1050w
NO-load speed: 0-1100/0-2800r/min
Drill capacity: 1.5-13mm
Impact rate: 27000/10000r/min



VGN13TK



**12V/1.3Ah
CORDLESS DRILL**

10mm keyless chuck
No-load speed: 0-580/min
3-5 Hr charge time
20 Torque setting
Variable speed
forward/reverse lever



VGN12V



**850Watt
ANGLE GRINDER**

Input power:850W
No-load speed:10000r/min
Voltage:220-240V
Frequency:50Hz
Diameter:115mm

VGN115



**2600Watt
ANGLE GRINDER**

Input Power: 2600w
NO-load speed: 8500r/min
Disc Diameter: 180mm
Voltage: 220-240v
Frequency: 50Hz

VGN180P



**2200Watt
ANGLE GRINDER**

Input power:2200W
No-load speed:8500r/min
Voltage:220-240V
Frequency:50Hz
Diameter:230mm

VGN230



**2600Watt
ANGLE GRINDER**

Input power:2600W
No-load speed:6500r/min
Voltage:220-240V
Frequency:50Hz
Diameter:230mm

VGN230P



**2200Watt
ANGLE GRINDER**

Input Power: 2200w
NO-load speed: 8500r/min
Disc Diameter: 180mm
Voltage: 220-240v
Frequency: 50Hz

VGN180



**1200Watt
POLISHER**

Input Power: 1200W
NO-load speed: 600-3000rpm
Voltage: 220-240V
Frequency: 50Hz
Diameter: 180mm

VGN P7



**1300Watt
POLISHER**

Input Power: 1300W
NO-load speed: 600-3000rpm
Voltage: 220-240V
Frequency: 50Hz
Diameter: 180mm

VGN P7S



**750Watt
JIG SAW**

No-load speed:500-3000/min
Power input:750W
Voltage:220-240V
Frequency:50Hz
Stroke:24mm
Cutting/wood:110mm
Cutting/aluminium:12mm
Cutting/non-alloyed steel:6mm

VGN 110J



**1200Watt
MARBLE CUTTER**

NO-load speed: 11000r/min
Max cutting: 110mm
Input Power: 1200w
Voltage: 220-240v
Frequency: 50Hz

VGN 110C

NETURAL PACKING



PROFESSIONAL PRODUCTS

SECTION VIGEX

DRILL
ANGLE GRINDER

INDUSTRY VIGEX



IMPACT DRILL

Voltage: 220/240V
Frequency: 50/60Hz
Drill capacity: 13mm
No-load speed: 0-3000rpm
Input power: 710W



IMPACT DRILL

Voltage: 220/240V
Frequency: 50/60Hz
Drill capacity: 13mm
No-load speed: 0-3000rpm
Input power: 800W



DEMOLATION BREAKER



220/240 V	50/60 Hz	2100 W	1000 -230mm ²
--------------	-------------	-----------	-----------------------------



ROTARY HAMMER DRILL



220/240 V	50/60 Hz	2100 W	100 -230mm ²	750 -395mm ²
--------------	-------------	-----------	----------------------------	----------------------------

**VGP115
ANGLE GRINDER**

Rated voltage:220-240V
rated frequency:50Hz
no-load speed:11000min⁻¹
grinding wheel diameter:115mm
rated input power:500w



ANGLE GRINDER

Rated voltage:220-240V
rated frequency:50Hz
no-load speed:4000-11000min⁻¹
grinding wheel diameter:115mm
rated input power:850w



ANGLE GRINDER

Rated voltage:220-240V
rated frequency:50Hz
no-load speed:11000min⁻¹
grinding wheel diameter:115mm
rated input power:850w



ANGLE GRINDER

Rated voltage:220-240V
rated frequency:50Hz
no-load speed:11000min⁻¹
grinding wheel diameter:125mm
rated input power:860w



ANGLE GRINDER

Rated voltage:220-240V
rated frequency:50Hz
no-load speed:4000-11000min⁻¹
grinding wheel diameter:115mm
rated input power:850w



ANGLE GRINDER

Rated voltage:220-240V
rated frequency:50Hz
no-load speed:6500min⁻¹
grinding wheel diameter:230mm
rated input power:2200w



ANGLE GRINDER

Rated voltage:220-240V
rated frequency:50Hz
no-load speed:6500min⁻¹
grinding wheel diameter:230mm
rated input power:2200w



BENCH GRINDER
SIZE: 5"
220-240V~ 50/60Hz
250W Ø150mm
n_o:2950rpm

LAWNMOWER

Features:
For small to medium size gardens
380mm cutting width
1400W induction motor
Adjustable cutting height
Safety switch and safety blade brake
Foldaway handle for easy storage
Grass collection box

1400W



Safety switch





1/2" DR 24PCS TOOL SET

Size: 10 11 12 13 14 15 16 17 18
19 20 21 22 23 24 27 30 32mm
Universal Joint
Ratchet Handle
Extension Bar 125mm
Extension Bar 250mm
Sliding T Bar 250mm
Ratchet Handle
Spark Plug



1/2" DR 24PCS SOCKET WRENCH SET

Size: 10 11 12 13 14 15 16 17 18
19 20 21 22 23 24 27 30 32mm

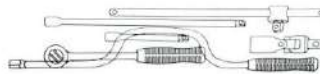

52PCS SOCKET WRENCH SET



1/4" & 1/2" DRIVE

- 1/2" Size: 10 11 12 13 14 15 17 19 22
24 27 30 32mm
- 1/4" Size: 4 4.5 5 5.5 6 7 8 9 10 11 13mm



21PC SOCKET SET

3/4" DR. 6PT/12PT
Size: 19-50MM



1/2" DR 24PCS TOOL SET

Size: 10 11 12 13 14 15 16 17 18
19 20 21 22 23 24 27 30 32mm

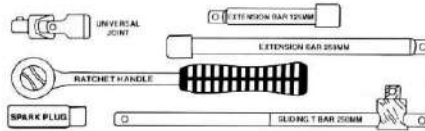

**24PCS SOCKET WRENCH SET
1/2" DR**



FLARING KIT



**16PCS
SOCKET WRENCH SET**



HEAVY DUTY ALUM.CASE



**HEAVY DUTY
ALUM.CASE**



**3 TRAY
STEEL TOOL BOX**



**5 TRAY
STEEL TOOL BOX**



7-DRAWER ROLLER TOOL CABINET



**ROLLER CABINET WITH HAND TOOLS
3+1 DRAWERS
COMPLETELY EQUIPPED**



79 PCS TOOL WITH METAL CASE 104884
DESCRIPTION / CONTENTS:

Material:
9PC SOCKET 1/2": CR-V
 10,12,13,14,17,19,22,24,27mm
2PC SPARK PLUG: 1/2"x16,21MM, CR-V
1PC DEEP SOCKET 1/2"x18MM, CR-V
2PC EXTENTION BAR 1/2"x 5" & 10", CR-V
1PC THREE WAY ADAPTOR, CR-V
1PC UNIVERSAL JIONT 1/2", CR-V
1PC RATCHET HANDLE 1/2", 72 TEETH, CR-V
11PC 1/4" SOCKET:
 4,4.5,5.5,5.6,7,8,9,10,11,12mm CR-V
1PC UNIVERSAL JIONT 1/4", CR-V
1PC EXTENTION BAR 1/4"x3", CR-V
1PC RATCHET HANDLE 1/4", 72TEETH , CR-V
18PC SOCKET BITS, CR-V
SLOTTED: 4-5-5-6.5MM PHILIPS:#1-#2-#3
HEX: 3,4,5,6,7,8MM

TORX: T10-T15-T20-T25-T30-T70
9PC HEX SET:
 1.5,2,2.5,3,4,5,6,8,10 mm. CR-V
1PC LONG NOSE PLIER 8" CS(carbon steel)
1PC HEAVY DUTY DIAGONAL PLIER 7"
1PC COMBINATION PLIER 7"
5PC SCREWDRIVERS CR-V:
 3x100,6x100,8x150MM
 PH1 X 75MM,PH2X 100MM
1PC WATER PUMP PLIER 250MM
1PC ADJUSTABLE WRENCH 250MM
1PC VICE PLIER 250MM
1PC CLAW HAMMER 12oz CS
7PC COMBINATION WRENCH:
 8,10,12,13,14,17,19MM
1PC MEASURING TAPE 3M
1PC BRASS CIRCUIT TESTER
METAL BOX 510X220X250MM

103 PCS MACHINIST TOOL WITH METAL BOX 104881
DESCRIPTION / CONTENTS:

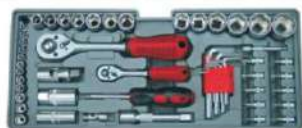
13PC 1/2" SOCKET:
 13,15,16,17,18,19,20,21,22,24,27,30,32mm
2PC SPARK PLUG: 1/2"x16,21MM
1PC EXTENTION BAR 1/2"x5"
1PC UNIVERSAL JIONT
1PC RATCHET HANDLE 1/2", 45TEETH
12PC 1/4" SOCKET:
 4,4.5,5.5,5.6,7,8,9,10,11,12,13mm
1PC UNIVERSAL JIONT
1PC EXTENTION BAR 1/4"x3"
1PC RATCHET HANDLE 1/4", 45TEETH
10PC SOCKET BITS
1PC BIT HANDLE 1/4"
9PC HEX SET 1.5-10MM
1PC LONG NOSE PLIER 6"
1PC SIDE CUTTING PLIER 6"
1PC COMBINATION PLIER 7"
4PC SCREWDRIVER BIT HANDLE
1PC SCREWDRIVER
32PC BITS 25MM
1PC EXTENSION BIT HOLDER 60MM
8PC COMBINATION WRENCH 8-19MM
1PC ADJUSTABLE WRENCH 8"
METAL BOX 510X220X250MM

85 PCS TOOL CASE 104855
DESCRIPTION / CONTENTS:

Material:Chrome Vanadium, Satin Finished
18PC 1/2" Dr. Sockets:
 10-11-12-13-14-15-16-17-18-19
 -20-21-22-23-24-27-30-32mm
1PC 1/2" Dr. 72 Teeth Quick Release Ratchet Handle.
1PC 1/2" Dr. x 5" Extension Bar
1PC 1/2" Dr. x 10" Extension Bar With 3-way Adaptor
1PC 1/2" Dr. Universal Joint
12PC 1/4"Dr.Socket:
 4,4.5,5.5,5.6,7,8,9,10,11,12,13mm.
1PC 1/4" Dr. 72 Teeth Quick Release Ratchet Handle.
1PC 1/4" Dr. x 3" Extension Bar
6PC 1/4" Socket Bits
1PC Screwdriver Handle
1PC Long Nose plier 6"
1PC Combination Plier 7"
1PC Measuring Tape 3M
1PC Zinc Alloy Cutter
10PC Blade
5PC Screwdriver: 5x75,6x100,6.5x150MM
 PH1 X 75MM,PH2X 100MM
1PC Water Pump Plier 9.5"
1PC Lock Plier 10"
9PC Hex Key: 1.5,2,2.5,3,4,5,6,8,10mm.
12PC Spanner 6,8,9,10,11,12,13,14,15,16,17,19MM
Metal Case

48 PCS TOOL SET WITH METAL CASE 104854
DESCRIPTION / CONTENTS:

Material:Chrome Vanadium, Satin Finished
8PC 3/8" Dr.Socket: 14,15,16,17,18,19,21,22 mm
1PC 3/8" Dr. x 3" Extension Bar
1PC Universal joint 3/8"
1PC Adaptor 3/8x1/4"
1PC 3/8" Dr. 72 Teeth Quick Release Ratchet Handle.
12PC 1/4"Dr.Socket: 4,4.5,5.5,5.6,7,8,9,10,11,12,13mm.
1PC Screwdriver Socket Handle1/4"
4PC Double open spanner carbon steel
 8x9,10x11,12x13,14x15mm
5PC Screwdriver: 5x75,6x100,6.5x150MM
 PH1 x 75MM,PH2 x 100MM
1PC Long Nose plier 6"(150mm)
1PC Combination Plier 7"(150mm)
1PC Water Pump Plier 9.5"(225mm)
1PC Lock Plier 240mm carbon steel
1PC Adjustable wrench carbon steel
10P CHex Key: 1.5,2,2.5,5.5,3,4,5,6,8,10mm.



180PC MACHINIST TOOL WITH METAL BOX 104853

DESCRIPTION / CONTENTS:

- 13PC 1/4"Dr. sockets 4-4.5-5-5.5-6-7-8-9-10 11-12-13-14mm
- 8PC 1/4"Dr. deep socket 6-7-8-9-10-11-12-13mm
- 2PC 1/4"Dr. extension bar 50-100mm
- 1PC 1/4"Dr. ratchet handle 72T
- 1PC 1/4"Dr. Universal joint
- 1PC 1/4"Dr. Flexible extension bar 150mm
- 1PC 1/4"Dr. x1/4" bits adapter
- 17PC 1/2"Dr. sockets 10-11-12-13-14-15-16-17-18 19-20-21-22-24-27-30-32mm
- 4PC 1/2"Dr. deep socket 14-15-17-19mm
- 2PC 1/2"Dr. spark plug socket 16-21mm
- 1PC 1/2"Dr. universal joint
- 2PC 1/2"Dr. extension bar 125-250mm
- 1PC 1/2"Dr. ratchet handle 72T
- 1PC 1/2"Dr. x8mm bits adapter
- 1PC 1/4"Dr. x 1/2" T-head
- 1PC 1/4"Dr. go thru spinner handle
- 15PC 8mm x 30mm L bits
- PH: #3-4, PZ: #3-4, SL: 8-10-12
- Torx: T40-45-50-55, Hex: 8-10-12-14

- 6PC Screwdriver (GS)
- PH: #2x38, #1x75, #2x100
- SL: 6.5x38, 5x75, 6.5x100
- 1PC Screwdriver bits driver 150mm
- 1PC Long nose pliers 200mm
- 1PC Linesman pliers 175mm
- 1PC Diagonal cutting pliers 150mm
- 9PC Hex key wrench (GS) 1.5-2-2.5-3-4-5-6-8-10mm
- 9PC Combination wrench (DIN) 8-10-11-12-13-14-17-19-22mm
- 1PC F.G. Mechanist hammer (GS) 300g
- 47PC Nail assortments
- 31PC Screwdriver bits box
- 1 x bits quick adapter
- Hex: 1.5-2-2.5-3-4-5-6
- SL: 3-4-4.5-5-5.5-6-7
- Poz: #0-1-2-3-4
- Phillips: #0-1-2-3-4
- Torx, temper proof: T10-15-20-25-27-30
- 1PC Metal box 4 layers, 535X260X330MM



ROLLER CABINET WITH HAND TOOLS 3+1 DRAWERS COMPLETELY EQUIPPED



56PC TOOL WITH METAL CASE 104702

DESCRIPTION / CONTENTS:

Material: Chrome Vanadium

13PC 3/8" SOCKET:

- 6, 7, 8, 9, 10, 11, 12, 13, 14, 15, 17, 19, 22mm
- 1PC EXTENSION BAR 3/8" X 3"
- 1PC UNIVERSAL JOINT 3/8"
- 2PC PLUG SOCKET 16, 21MM
- 1PC RATCHET HANDLE 3/8", 72 TEETH
- 1PC MACHINIST HAMMER 300G
- 1PC 3M MEASURING TAPE

10PC HEX KEY WRENCH 1.5-10MM

- 2PC SCREWDRIVER 6X100MM, PH2X100MM
- 1PC RATCHET BIT HANDLE
- 1PC ADJUSTABLE WRENCH
- 18PC BITS 25MM, CR-V
- 1PC 6" LONG NOSE PLIER
- 1PC 7" COMBINATION PLIER
- 1PC 10" WATER PUMP PLIER
- 1PC METAL TOOL CASE SIZE: 427X180X180MM

Passed 1Hr fire rating

Passed NT fire 017-90, SP fire rating / certi No. 106602
 Passed 2Hrs JIS fire rating / certi No. 23722
 passed 1Hrs KS fire rating



Choice of lock system: digital, Dial combination, and two key type



- | | | | | | |
|---|--|--|--|---|---|
| <p>SD-104
 outside: H628XW494XD550mm
 inside: H424XW345XD341mm
 approx. Wt: 100Kgs/220Lbs
 fittings: 1plastic tray,
 2adjustable shelves</p> | <p>SD-105
 outside: H718XW494XD550mm
 inside: H514XW345XD341mm
 approx. Wt: 127Kgs/280Lbs
 fittings: 1plastic tray
 2adjustable shelves</p> | <p>E5D-680
 outside: H680XW452XD516mm
 inside: H480XW312XD324mm
 approx. Wt: 94Kgs/207Lbs
 fittings: 1lockable drawer,
 1adjustable shelf</p> | <p>SD-105A
 outside: H675XW478XD533mm
 inside: H464XW312XD330mm
 approx. Wt: 110Kgs/240Lbs
 fittings: 1plastic tray,
 2adjustable shelves</p> | <p>E5D-106
 outside: H850XW580XD553mm
 inside: H623XW433XD345mm
 approx. Wt: 172Kgs/380Lbs
 fittings: 1lockable drawer,
 1adjustable shelf</p> | <p>DS-106E
 outside: H850XW580XD553mm
 inside: H623XW433XD345mm
 approx. Wt: 172Kgs/380Lbs
 fittings: 1lockable drawer,
 1adjustable shelf</p> |
|---|--|--|--|---|---|



Size: 6", 8, 10, 12"
ADJUSTABLE WRENCH



ADJUSTABLE WRENCH
Size: 18", 24"



HAMMER WRENCH
Size: 24, 27, 30, 32, 36, 41, 46, 50, 55, 60, 65, 70, 75, 80, 85, 90, 95, 100, 105, 110, 115MM



Size: 10"
Size: 12"
Size: 15"

ADJUSTABLE WRENCH



COMBINATION WRENCH SET EXTRA LONG
SPECIFICATION:
Drop forged steel
Mirror polished
Industrial quality
suitable for intricate work
Size: 8mm, 9mm, 10mm, 11mm, 12mm, 13mm, 14mm, 15mm, 16mm, 17mm, 18mm, 19mm



12 PCS EXTRA LONG COMBINATION WRENCH SET

SPECIFICATION:
Mirror polished
Industrial quality
cushion grip
suitable for intricate work
Size: 8 9 10 11 12 13 14 15 16 17 18 19



DOUBLE OFFSET RING SPANNER
Size: 6X7 8X9 10X11 12X13 14X15 16X17 18X19 20X22 21X23 24X26 25X28 30X32



COMBINATION WRENCH
Size: 6 8 9 10 11 12 13 14 15 16 17 18 19 21 22 23 24 25 26 27 28 29 30 31 32 33 34 36 37 38 39 40 41 42 43 44 45 50 55 57 60 65 70 75 80 85mm



12 PCS EUROPEAN TYPE DOUBLE RING OFFSET WRENCH SET

Size: 6X7 8X9 10X11 12X13 14X15 16X17 18X19 20X22 21X23 24X26 25X28 30X32



9 PCS TORX HEX KEY SET WITH HOLE

Size: T10 T15 T20 T25 T27 T30 T40 T45 T50 CRV



9 PCS HEX KEY SET

Size: 1.5 2 2.5 3 4 5 6 8 10mm CRV



9 PCS BALL POINT HEX KEY SET

Size: 1.5 2 2.5 3 4 5 6 8 10mm CRV



L TYPE WRENCH
Deep nut driver
CRV
Size: 10, 11, 12, 13, 17, 19, 21, 22, 24, 27MM



T TYPE WRENCH
Deep nut driver
CRV
Size: 8 9 10 11 12 13 14 15 16 17 18 19mm



IMPACT EXTENSION BAR
5"X3/4"
5"X1"
6"X3/4"
6"X1"
8"X3/4"
8"X1"



IMPACT ADAPTER
Size: 3/4"X1/2"; 3/4"X1"



PIPE WRENCH



TORQUE WRENCH
Size: 20Kg 30Kg



6PCS JUMBO HEX KEY WRENCH SET

Size: 8 10 12 14 17 19mm
Heat-treated steel
Rugged, Black oxide finish
Industrial quality
Metric size



9PCS FOLDING HEX KEY

Folds away for easy storage
manufactured from chrome vanadium steel.
Nickel plated Ergonomic rubber cushion grip
Size: 2 4 5.5 5 4.5 1.5 6 3 2.5mm



Range: 15-52mm
ADJUST PIN WRENCH



12PCS JUMBO HEX KEY WRENCH SET

Size: 8 10 12 14 17 19mm
3/8" 7/16" 1/2" 9/16" 5/8" 3/4"
Heat-treated steel
Rugged, Black oxide finish
Industrial quality



SELF ADJUSTING OIL FILTER WRENCH

350mm
Drop forged, heat treated steel
durable baked enamel finish
quick gripping precision machined jaws
with slip joint design enables greater range
optimum grip and torque
fits all filler elements on most domestic cars and trucks

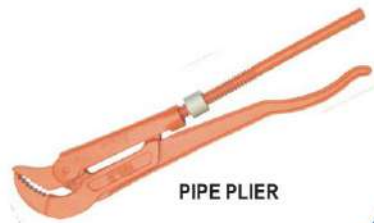

PIPE PLIER



WATER PUMP PLIER
Professional
Size: 10", 12"



PIPE WRENCH
Professional
Size: 8" 10" 12" 14" 16" 24" 36" 48"



PIPE WRENCH



PIPE WRENCH



PIPE WRENCH



MONKEY PLIER
Professional
Size: 9" 10.5" 12"



10" LOCKING PLIER with soft grip handle
Drop forged. Heat treated steel jaws. Black nickel finishing with quick release lever



7" COMBINATION PLIER 50036-7
Fully polished micro plating finish
Heavy duty design
Comfortable soft grip



7" HEAVY DUTY SIDE COLLER PLIER 50037
Drop forged
Fully polished micro plating finish
Heavy duty design
Comfortable soft grip



6" LONE NOSE PLIER 50038-6
Drop forged
Fully polished micro plating finish
Heavy duty design
Comfortable soft grip



ELECTRONIC COMBINATION PLIER
Heavy duty industrial quality
SIZE: 7" 8"



ELECTRONIC LONG NOSE PLIER
Heavy duty industrial quality
SIZE: 7" 8"



ELECTRONIC LONG NOSE PLIER
Heavy duty industrial quality
SIZE: 6" 8"



SUPER CIRCLIP PLIER
SIZE: 9" 12"

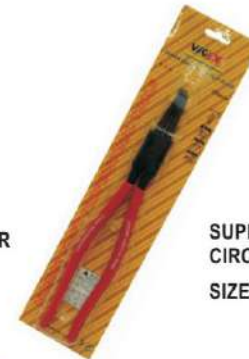

SUPER CIRCLIP PLIER
SIZE: 9" 12"



SUPER CIRCLIP PLIER
SIZE: 9" 12"



4PCS CIRCLIP PLIER SET IN POUCH BAG
SIZE: 4PCS 7"
4PCS 8"



3PCS PLIER SET
SIZE: 6" 3PC
7" 3PC
8" 3PC



2 in 1 7" DOUBLE END CIRCLIP PLIER SET
Makes removing and installing snap rings fast and easy! Works on both internal and external style snap rings. Snap ring fits into grooves, providing a shoulder for holding components in place. Release easily when ring is in position



EASY STRIPPER



ELECTRODE HOLDER
600 Amp.



ELECTRODE HOLDER
SH-800 Amp.



ELECTRODE HOLDER
600 Amp.



Use mask and gloves

Electrode position

Connect the masse very well

ELECTRODE HOLDER



Mod. VULCAN
300 Amp.
Mod. VULCAN
500 Amp.



BALL PEN HAMMER
WITH YELLOW FIBERGLASS HANDLE

EU-BF-12 OZ
EU-BF-16 OZ
EU-BF-20 OZ
EU-BF-24 OZ



BRASS SLEDGE HAMMER
WITH YELLOW FIBERGLASS HANDLE

SIZE:
1LBS 2LBS 3LBS
4LBS 6LBS



CLAW HAMMER
SIZE:
0.25 KGS
0.5 KGS
0.75 KGS



SLEDGE HAMMER
SIZE:
2LBS, 3LBS, 4LBS, 6LBS,
8LBS, 10LBS, 12LBS, 14LBS,
16LBS, 18LBS, 20LBS



STONING HAMMER
WITH WOOD HANDLE



STONING HAMMER
WITH FIBREGLASS HANDLE



HAND AXE WITH FIBREGLASS HANDLE
500G

HAND AXE,
DROP FORGED,
BLACK HEAD,
FIBREGLASS HANDLE,
600G X 14"
1250G X 32"
1600G X 36"
2000G X 36"



PIPE CUTTER
RED PAINTED BODY
NO.1# 3-22MM
NO.2# 12-50MM
NO.3# 75MM
NO.4# 50-100MM



MULTI-PURPOSE SAW
Two types of interchangeable blade (fine and large teeth) allow one to tackle many tasks.
Pruning
carpentry
civil engineering



3PCS POINT CHISEL



TITANIUM DRILL BIT
3, 3.5, 4, 5, 6, 8, 10, 12, 13, 14, 15, 16, 17, 18, 20MM



SDS MASONRY DRILL BIT

6X160MM	12X260MM	20X300MM
6X210MM	14X200MM	20X450MM
7X160MM	14X260MM	22X250MM
8X180MM	14X300MM	22X300MM
8X210MM	16X200MM	
8X260MM	16X260MM	
10X160MM	16X300MM	
10X210MM	18X200MM	
10X310MM	18X250MM	
12X160MM	18X300MM	



6 PCS CHISEL & PUNCH SET
Deflector provides added protection against misplaced blows
rubber handle for added comfort
forged, heat-treated chrome-vanadium steel
set includes 1 centre punch 1 solid punch 1 pin punch & 3 cold chisel



6 PCS PUNCH & CHISEL SET
1 PC CENTER PUNCH: 5/32"x6"
1 PC TAPER PUNCH: 1/8"x6"
1 PC PIN PUNCH: 3/16"x6"
3 PC COLD CHISEL: 1/2"x6-1/2", 5/8"x7", 3/4"x8"
WITH HEAVY DUTY STORAGE POUCH
DROP FORGED AND HEAT TREATED ALLOY STEEL



3 PIECE COLD CHISEL SET

Hardened and tempered chrome vanadium steel Set supplied with composite chisel retainer.

- 3/8" 10mm
- 5/8" 16mm
- 1/2" 12mm



6 PIECE COLD CHISEL & PUNCH SET

Hardened and tempered Chrome vanadium steel 2 pc pin punch, 1 pc taper punch 1 pc center punch, 2 pc cold chisel

- 5/16" 8mm
- 3/32" 2mm
- 3/8" 10mm
- 1/2" 12mm
- 1/4" 6mm
- 1/8" 3mm



3 PIECE PIN PUNCH SET

Hardened and tempered Chrome vanadium steel Set supplied with composite Chisel retainer.

- 1/32" 0.8mm
- 1/16" 1.5mm
- 3/32" 2.5mm



14PCS PUNCH AND CHISEL SET

4 PIN PUNCHES: 5x10x150, 3x10x125, 2x10x125, 6x13x150mm
1 center punch: 3x10x125mm
4 taper punches: 10x16x250, 8x13x275, 3x12x290, 3x10x275mm
5 cold chisel: 13x10x150, 16x13x175, 10x16x175, 22x16x200, 25x19x215mm



14 PCS PUNCH & CHISEL SET

WITH HEAVY DUTY STORAGE POUCH
DROP FORGED AND HEAT TREATED HIGH CARBON STEEL

- 4 PCS PIN PUNCH: 3/16" X 3/8" 6", 1/8" X 3/8" 6", 3/32" X 3/8" 6", 1/4" X 1/2" 6"
- 1 PCS CENTER PUNCH: 1/8" X 3/8" 6"
- 4 PCS TAPER PUNCH: 3/16" X 8/8" 10", 3/32" X 1/2" 6", 1/8" X 1/2" 10", 1/8" X 3/8" 8-1/2"
- 5 PCS COLD CHISEL: 1/2" X 3/8" 6, 3/8" X 1/2" 7, 3/4" X 3/8" 7, 7/8" X 5/8" 6, 1" X 3/4" 8-1/2"



4 PCS LONG TAPER PUNCH SET

DROP FORGED AND HEAT TREATED PRECISION GROUND BLADES. SNAP IN STORAGE CASE

- 5/32" X 12"
- 3/16" X 14"
- 1/4" X 16"
- 3/8" X 18"



12 PCS CARVING CHISEL SET

HIGH CARBON STEEL
PRECISION POLISHED BLADE
DURABLE WOODEN HANDLE

- 7/32" STRAIGHT
- 15/32" STRAIGHT
- 3/8" V-TOOL
- 7/32" RIGHT SKEW
- 7/32" GOUGE
- 3/8" GOUGE
- 7/32" SPOON BIT
- 5/16" GOUGE
- 7/32" DOUBLE SKEW
- 7/32" BEADING
- 7/32" V-GROOVE
- 7/32" ROUND ROSE



12 PCS CARVING CHISEL SET

HIGH CARBON STEEL
PRECISION POLISHED BLADE
DURABLE WOODEN HANDLE

- 7/32" STRAIGHT
- 15/32" STRAIGHT
- 3/8" V-TOOL
- 7/32" RIGHT SKEW
- 7/32" GOUGE
- 3/8" GOUGE
- 7/32" SPOON BIT
- 5/16" GOUGE
- 7/32" DOUBLE SKEW
- 7/32" BEADING
- 7/32" V-GROOVE
- 7/32" ROUND ROSE



5 PCS LONG PIN PUNCH SET
SIZE: 1/8" 3/16" 1/4" 5/16" 3/8"



6PCS HOLLOW PUNCH SET



7PCS HOLLOW PUNCH SET



13-IN-1 HOLLOW PUNCH SET

Drop forged, heat treated alloy steel. precision ground flutes and cutting edges. Hollow punches make clean holes in gaskets, leather, plastic, rubber, vinyl, paper, and other soft materials.



8 PIECE PUNCH & CHISEL SET

Drop forged, heat-treated Precision ground and polished blades Snap-in moulded carrying case
3 pcs cold chisel: 1-1/4" X 3/4" X 9"
1" X 5/8" X 8-1/2", 7/8" X 1/2" X 8"
Center punch: 3/16" X 1/2" X 8"
2 pcs pin punch: 3/8" X 1/2" X 8-3/4", 1/2" X 5/8" X 8-3/4"
2 pcs taper punch: 3/16" X 1/2" X 10", 3/8" X 1/2" X 10"



4PCS COLD CHISEL SET

- 18X250mm
- 18X300mm
- 18X350mm
- 18X400mm



SIZE: 5mm, 6mm, 8mm, 10mm, 11mm, 13mm, 16mm, 19mm, 22mm, 25mm, 28mm, 32mm, 35mm.



2.0mm NUMBER PUNCH

Set of 9 numeric punches (number 6 doubles as 9). Chrome vanadium hardened and tempered



2.0mm LETTER PUNCH

Heat-treated chrome vanadium steel construction Each punch measures 1/8 inch in diameter x 2-1/2 inches long Set includes 36 punches marked A-Z plastic storage box



ROUTER BIT
SLOT CUTTER R 1/2"



WOOD BORING BIT
SIZE: 35mm



20PCS ROUTER BIT SET

- | | |
|----------------------------------|----------------------------|
| STRAIGHT BIT S×6×20 | COVE BOX BIT S×R6×12 |
| STRAIGHT BIT S×6×25 | PANEL PILOT BIT S×1/4"×19 |
| STRAIGHT BIT S×8×20 | ROUND NOSE BIT S×R6×12 |
| STRAIGHT BIT S×10×20 | FLUSH TRIM BIT S×12.7×12.7 |
| STRAIGHT BIT S×12×30 | FLUSH TRIM BIT S×12.7×25 |
| STRAIGHT BIT S×14×20 | SLOT CUTTER BIT S×32×10 |
| STRAIGHT BIT S×16×20 | 45° CHAMFER BIT S×37×16 |
| STRAIGHT BIT S×19×20 | ROUND OVER BIT S×R9.5×16 |
| DOVETAIL BIT S×14.3×14 | BEADING BIT S×R12.7×19 |
| 90° "V" GROOVING BIT-S×12.7×12.7 | COVE BIT S×R9.5×13 |



35PCS ROUTER BIT SET

- | | |
|------------------------------------|---------------------------------|
| BEARING FLUSH TRIM BIT S×3/8"×1/2" | BEADING BIT S×R1/2" |
| BEARING FLUSH TRIM BIT S×3/8"×1 | COVE BIT S×R1/4" |
| BEARING FLUSH TRIM BIT S×1/2"×1/2" | COVE BIT S×R3/8" |
| BEARING FLUSH TRIM BIT S×1/2"×1 | COVE BIT S×R1/2" |
| BEARING FLUSH TRIM BIT S×3/4"×1 | ROMAN OGEE BIT S×R5/32" |
| SLOT CUTTER BIT S×1-1/4"×1/4" | ROMAN OGEE BIT S×R7/32" |
| SLOT CUTTER BIT S×1-1/4"×5/16" | ROMAN OGEE BIT S×R9/32" |
| SLOT CUTTER BIT S×1-1/4"×3/8" | OGEE PANEL BIT S×R3/16" |
| SLOT CUTTER BIT S×1-1/4"×1/2" | OGEE PANEL BIT S×R1/4" |
| 45° CHAMFER BIT S×3/8"×1 | OGEE PANEL BIT S×R3/16" |
| 45° CHAMFER BIT S×1/2"×1-3/16" | 45° CLASSICAL COVE BIT S×R5/16" |
| 45° CHAMFER BITS×5/8"×1-7/16" | WAVE EDGE BIT S×R3/16" |
| 45° CHAMFER BITS×3/4"×1-5/8" | CLASSICAL BIT S×R3/16" |
| COVNER ROUNDING OVER BIT S×R1/4" | CLASSICAL BIT S×R1/4" |
| COVNER ROUNDING OVER BIT S×R3/8" | COUBLE OGEE PANEL BIT S×R1/8" |
| COVNER ROUNDING OVER BIT S×R1/2" | COUBLE OGEE PANEL BIT S×R3/16" |
| BEADING BIT S×R1/4" | COUBLE OGEE PANEL BIT S×R1/4" |
| BEADING BIT S×R3/8" | |



50PCS ROUTER BIT SET

- | | |
|---|---------------------------------|
| 7PCS STRAIGHT BIT S×3/16, 1/4, 5/16, 3/8, 1/2, 5/8, 3/4inch | S×R1/4, R3/8, R1/2inch |
| 2PCS 90° V GROOVE BIT S×3/8, 1/2inch | 3PCS BEADING BIT |
| 2PCS DOVETAIL BIT S×1/2, 9/16inch | S×R1/4, R3/8, R1/2inch |
| 3PCS CORE BOX BIT | 3PCS COVE BIT |
| S×R1/8, R3/16, R1/4inch | S×R1/4, R3/8, R1/2inch |
| 1PCS PANEL PILOT BIT | 3PCS ROMAN OGEE BIT |
| S×1/4inch | S×R5/32, R7/32, R9/32inch |
| 5PCS FLUSH TRIM BIT | 2PCS OGEE PANEL BIT |
| S×3/8×1/2, 3/8×1 | S×R1/4, R3/8inch |
| 1/2×1/2, 1/2×1, 3/4×1inch | 1PCS OGEE FLUTE BIT S×R3/16inch |
| 4PCS SLOT CUTTER BIT | 1PCS CLASSICAL COVE BIT |
| S×1/4, 5/16, 3/8, 1/2inch | S×R5/16inch |
| 4PCS CHAMFER BIT | 1PCS WAVY EDGE BIT |
| S×3/8×1, 1/2×1-3/16 | S×R3/16inch |
| 5/8×1-7/16, 3/4×1-5/8inch | 2PCS CLASSICAL BIT |
| 3PCS ROUND OVER BIT | S×R3/16, R1/4inch |
| | 3PCS DOUDLE ROMAN OGEE BIT |
| | S×R1/8, R3/16, R1/4inch |



20PCS ROUTER BIT SET

- | | |
|----------------------------------|----------------------------|
| STRAIGHT BIT S×6×20 | COVE BOX BIT S×R6×12 |
| STRAIGHT BIT S×6×25 | PANEL PILOT BIT S×1/4"×19 |
| STRAIGHT BIT S×8×20 | ROUND NOSE BIT S×R6×12 |
| STRAIGHT BIT S×10×20 | FLUSH TRIM BIT S×12.7×12.7 |
| STRAIGHT BIT S×12×30 | FLUSH TRIM BIT S×12.7×25 |
| STRAIGHT BIT S×14×20 | SLOT CUTTER BIT S×32×10 |
| STRAIGHT BIT S×16×20 | 45° CHAMFER BIT S×37×16 |
| STRAIGHT BIT S×19×20 | ROUND OVER BIT S×R9.5×16 |
| DOVETAIL BIT S×14.3×14 | BEADING BIT S×R12.7×19 |
| 90° "V" GROOVING BIT-S×12.7×12.7 | COVE BIT S×R9.5×13 |



35PCS ROUTER BIT SET

- | | |
|------------------------------------|--------------------------------|
| BEARING FLUSH TRIM BIT S×3/8"×1/2" | BEADING BIT S×R1/2" |
| BEARING FLUSH TRIM BIT S×3/8"×1 | COVE BIT S×R1/4" |
| BEARING FLUSH TRIM BIT S×1/2"×1/2" | COVE BIT S×R3/8" |
| BEARING FLUSH TRIM BIT S×1/2"×1 | COVE BIT S×R1/2" |
| BEARING FLUSH TRIM BIT S×3/4"×1 | ROMAN OGEE BIT S×R5/32" |
| SLOT CUTTER BIT S×1-1/4"×1/4" | ROMAN OGEE BIT S×R7/32" |
| SLOT CUTTER BIT S×1-1/4"×5/16" | ROMAN OGEE BIT S×R9/32" |
| SLOT CUTTER BIT S×1-1/4"×3/8" | OGEE PANEL BIT S×R3/16" |
| SLOT CUTTER BIT S×1-1/4"×1/2" | OGEE PANEL BIT S×R1/4" |
| 45° CHAMFER BIT S×3/8"×1 | OGEE PANEL BIT S×R3/16" |
| 45° CHAMFER BIT S×1/2"×1-3/16" | CLASSICAL COVE BIT S×R5/16" |
| 45° CHAMFER BITS×5/8"×1-7/16" | WAVE EDGE BIT S×R3/16" |
| 45° CHAMFER BITS×3/4"×1-5/8" | CLASSICAL BIT S×R3/16" |
| COVNER ROUNDING OVER BIT S×R1/4" | CLASSICAL BIT S×R1/4" |
| COVNER ROUNDING OVER BIT S×R3/8" | COUBLE OGEE PANEL BIT S×R1/8" |
| COVNER ROUNDING OVER BIT S×R1/2" | COUBLE OGEE PANEL BIT S×R3/16" |
| BEADING BIT S×R1/4" | COUBLE OGEE PANEL BIT S×R1/4" |
| BEADING BIT S×R3/8" | |



50PCS ROUTER BIT SET

- | | |
|---|---------------------------------|
| 7PCS STRAIGHT BIT S×3/16, 1/4, 5/16, 3/8, 1/2, 5/8, 3/4inch | S×R1/4, R3/8, R1/2inch |
| 2PCS 90° V GROOVE BIT S×3/8, 1/2inch | 3PCS BEADING BIT |
| 2PCS DOVETAIL BIT S×1/2, 9/16inch | S×R1/4, R3/8, R1/2inch |
| 3PCS CORE BOX BIT | 3PCS COVE BIT |
| S×R1/8, R3/16, R1/4inch | S×R1/4, R3/8, R1/2inch |
| 1PCS PANEL PILOT BIT | 3PCS ROMAN OGEE BIT |
| S×1/4inch | S×R5/32, R7/32, R9/32inch |
| 5PCS FLUSH TRIM BIT | 2PCS OGEE PANEL BIT |
| S×3/8×1/2, 3/8×1 | S×R1/4, R3/8inch |
| 1/2×1/2, 1/2×1, 3/4×1inch | 1PCS OGEE FLUTE BIT S×R3/16inch |
| 4PCS SLOT CUTTER BIT | 1PCS CLASSICAL COVE BIT |
| S×1/4, 5/16, 3/8, 1/2inch | S×R5/16inch |
| 4PCS CHAMFER BIT | 1PCS WAVY EDGE BIT |
| S×3/8×1, 1/2×1-3/16 | S×R3/16inch |
| 5/8×1-7/16, 3/4×1-5/8inch | 2PCS CLASSICAL BIT |
| 3PCS ROUND OVER BIT | S×R3/16, R1/4inch |
| | 3PCS DOUDLE ROMAN OGEE BIT |
| | S×R1/8, R3/16, R1/4inch |





LASER WELDED DIAMOND CUTTING DISC
 Max 80 m/s Max : 80m/s Max : 80m/s
 Max 13300rpm Max : 7500rpm Max : 5800rpm
 115X9X22.2MM 180X14X22.2MM 230X16X22.2MM



DIAMOND DRY CUTTING DISC
 Max 80 m/s Max 80 m/s Max 80 m/s
 Max 14500rpm Max 13200rpm Max 8700rpm
 Ø105X7X20MM Ø115X7X22.23MM Ø180X7X22.23MM



**Even tooth
25.4mm bore**

TCT BLADE

7"/40 Teeth	Ø = 100mm MAX RPM = 7000	12"/72 Teeth	Ø = 300mm MAX RPM = 3000
9"/60 Teeth	Ø = 220mm MAX RPM = 5000	14"/100 Teeth	Ø = 350mm MAX RPM = 4000
10"/60 Teeth	Ø = 280mm MAX RPM = 6000	16"/120 Teeth	Ø = 400mm MAX RPM = 3000



PIPE CUTTER SIZE:1-3/8"



2 PIECE MINI MULTI TOOL SET

Contents 6 in 1 mini multi purpose tool and 10 in 1 mini multi knife foldable and light weight

**VG8818A
UTILITY KNIFE**



4" ELECTRICIAN KNIFE

Stainless steel blade
 Best wooden handle
 Four rivets



TINMAN'S SNIP 8"

Anti-slip pvc
 Dipped handle
 Heavy duty
 industrial quality



**HACKSAW FRAME
12"/300MM**

COMFORTABLE GRIP HANDLE
 FLAT STEEL FRAME



SANDBLAST GUN

Size:5,6,7,8,10,12mm.
 Transparent handle.
 Heat treated.



CABLE WIRE STRIPPER

3 high quality blade.
 8-28mm.



CABLE CUTTER



SIZE: 18",
 SIZE: 24",
 SIZE: 36",
 SIZE: 42"

BOLT CUTTER



RATCHET PRUNER



RATCHET PRUNER



GARDEN PRUNER

CHAIN PIPE WRENCH

Drop-forged handle and jaws.



size: 1-1/2"
length: 350mm

size: 2-1/2"
length: 690mm



Size	Length	Jaw drop-forged.
4"	100mm	Jaw teeth induction quenched for durable using.
6"	150mm	Dual side jaw for easy change.
8"	200mm	Used for pipe construction, oil-field production and drilling operation.
10"	250mm	
12"	300mm	
16"	324mm	

Jaw drop-forged.
Jaw teeth induction quenched for durable using.
Dual side jaw for easy change.
Used for pipe construction, oil-field production and drilling operation.



PIPE VISE WITH TRIPOD STAND

Body made of malleable cast iron. Teeth milled heat treatment. Used for pipe construction outdoors.

Size	Length
0#	10-40
2#	10-90
3#	15-115



HAND SHEAR
SIZE: 6"



HAND CUTTER



BRICK CUTTER



300MM TILE CUTTER

With heavy duty steel base and steel bar handle. Tungsten carbide steel cutter blades. Professional quality. Straight cutting capacity 12 inch.



400MM TILE CUTTER

With heavy duty steel base and steel bar handle. Tungsten carbide steel cutter blades. Professional quality. Straight cutting capacity 16 inch.



3 IN 1 MULTI-FUNCTION TILE CUTTER 400MM

With heavy duty steel base and steel bar handle. Tungsten carbide steel cutter blades. Professional quality. Adjustable hole cutting from 1-3/16 inch to 3-1/4 inch. Straight cutting capacity 15-3/4 inch.



LONG FIBREGLASS MEASURING TAPE

30M/100FT
50M/165FT
100M/330FT

SELF-LOCK MEASURING TAPE



SIZE: 3M
SIZE: 5M
SIZE: 7.5M



SELF-LOCK MEASURING TAPE

Chrome plate High-impact-resistant ABS safety case. 2-rivet sliding end hook for inside and outside measurements. Belt clip. Shockproof. Best quality rubber covered case measure tape. Easy to lock and to release.

3m/10FTX16mm
5m/16FTX19mm
7.5m/25FTX25mm



4-WAYS VERNIER CLIP
SIZE: 6" 8" 12"



DIGITAL VERNIER CLIP



WHEEL MEASURING



WHEEL MEASURING DIGITAL DISPLAY
SIZE: 10000M



DOUBLE DIALS SPRING PLATFORM SCALE
SIZE: 50KG
SIZE: 100KG
SIZE: 150KG



ELECTRONIC PLATFORM SCALE



ELECTRONIC PLATFORM SCALE



DOUBLE DIALS SPRING PLATFORM SCALE
SIZE: 10000M



DIGITAL SCALE
SIZE: 15KG
SIZE: 30KG

DIAL TYPE GAUGE



Ideal product of type pressure test.
Capacity: 0-140 PSI 0-10 BAR

TYRE INFLATING GUN



Inflating: fully press inflating trigger.
Over pressure release: press the lateral push-button.

AIR SPRAY GUN 600ML



Semi-professional spray gun suitable for all types of surface: metal, glass, ceramics, wood, plastic, etc.

SPRAY GUN 1000ML



Semi-professional spray gun suitable for all types of surface: metal, glass, ceramics, wood, plastic, etc.

PROFESSIONAL AIR EPOXY GUN



Comfortable, light-weight one piece aluminium body with long steel trigger.
Air shut-off valve allows for control of air pressure.
Plastic tank.

PROFESSIONAL AIR EPOXY GUN



Comfortable, light-weight one piece aluminium body with long steel trigger.
Air shut-off valve allows for control of air pressure.
Aluminium tank.

MINI SPRAY GUN



Ideal for spray-painting art, drawing, toys and crafts.
Nozzle size: \varnothing 0.5mm.
Fluid (water) delivery: 50ml/min.
Air pressure: 70psi.
Capacity: 200ml.

GRAVITY FEED SPRAY GUN



Saves paint and protects the environment.
high quality construction
better than 75% transfer efficiency with less than 10% psi output pressure
stainless steel nozzle, stainless iron needle.

AIR SPRAY GUN



Operating air pressure: 30-120 psi
Pot capacity: 1000cc.
Comfortable, light-weight one piece aluminium body.

**HAND SPRAYER
16 LITRE**



KNAPSACK HAND SPRAYER

Tank capacity: 16L
Left and right operation interchangeable
Cone nozzle and fan nozzle are supplied with unit
Quick pressure
brass lance



KNAPSACK HAND SPRAYER

Tank capacity: 20L
Left and right operation interchangeable
Cone nozzle and fan nozzle are supplied with unit
Quick pressure
brass lance

SOLDERING BURNER

Soldering burner working with UNIVERSAL piercing cartridge.
Brass valves approved by TUE.
Safety and reliability.



DRAIN CLEANER

Easily spins.
Convenient firm grip hand.



VACUUM FUNCTION PUMP

Hand vacuum pump,
hand-operated vacuum pump.



ACETYLENE REGULATOR



**WATER PUMP
PRESSURE TANK**

Capacity: 24L
Thickness: 1.0mm
Max pressure: 8 bar



OXYGEN REGULATOR



**PRESSURE
SPRAYER**

2L

2L capacity tank.
Adjustable poly nozzle which can spray a fine mist.
Durable poly construction.
Designed for light jobs.



SANDBLAST GUN

Standard tip of nozzle:6.0mm.
Air inlet: 1/4" NPT
Siphon hose length: 1.5mm



DIESEL WASHING GUN

Operating air pressure: 30~120 psi
Pot capacity: 750cc.
Comfortable,
light-weight one
piece aluminium
body with long
steel trigger.



AIR DUSTER GUN

Aluminium body,
Nickel plated



ELECTRIC SPRAY GUN

Rated voltage:230V
Rated frequency:50Hz
Rated power:300W
Paint reservoir:700ml
Max. viscosity:30din/sec
Max. Flow:280ml/min



ELECTRIC SPRAY GUN

Voltage:220-240V
Frequency:50/60Hz
Input power: 75W
Operation Speed:260ml/min
Capacity: 1000ml
Light Weight Compact Design



**ECONOMY MODEL 75W
ELECTRIC SPRAY GUN**
220-240V 50-60Hz
POWER: 75W
Capacity: 1000ml



**ECONOMY MODEL 80W
ELECTRIC SPRAY GUN**
220-240V 50-60Hz
POWER: 80W
Capacity: 1000ml



AIR IMPACT WREN CH



AIR IMPACT WREN CH



AIR STAPLER

Required pressure:
60-120PSI(4-7bar),
nail size: 20 gauge 1.20X0.60mm,
11.2mm crown,
Nail capacity:100PCS.
Includes:
1PC stapler, 1PC oil, 2PC hex key,
100PC nail and operating manual
APPLICATION:
Upholstery Wooden case
Paper board Toys
Window shade Cabinet backs
Furniture backs



5PCS QUICK COUPLER SET

1-pc 1/4 NPT female thread quick coupler.
3-pc 1/4 NPT male thread quick coupler.
1-pc 1/4 NPT male thread connector.
Use with all air operated equipment.
Brass body.



5PCS QUICK COUPLER SET

1-pc 1/4 NPT female thread quick coupler.
3-pc 1/4 NPT male thread quick coupler.
1-pc 1/4 NPT male thread connector.
Use with all air operated equipment.
Steel body nickel plated.



AIR HOSE NIPPLE WITH NUT

Steel body nickel plated



**BLACK
RUBBER AIR HOSE**

Size: 8mmx 15mmx 50m



**QUICK RELEASE
COUPLING**



HEAVY DUTY AIR IMPACT WREN CH



Reverse lever in forward and reverse,
and 3-position power regulator.
Components with durable and heavy duty
materials.
Removable side handle provides excellent
control, ideal for high volume repair works
on trucks, tires and heavy equipment.

500CC GREASE GUN



Sturdy construction for high pressure. Quality pump head with jam-proof toggle mechanism prevents binding & accidental bending of plunger. Checking valve easily, accessible cleaning without gun disassembly. Insulated pipe.



HAND OIL PUMP

Equipped with a self-adjusting telescopic suction tube for pumping all contents from 15 to 55 gallon drums. 2" and 1-1/2" NPT bung nut. Cushioned vinyl handle. Dispenses approximately 300cc liquids per stroke.

HAND OPERATED OIL PUMP



SUCTION DISTANCE:	1M
LIFT DISTANCE:	0.5M
FLOW RATE:	24 L/MIN
ROTARY RATE:	70
OUT DIAMETER:	32MM
INNER DIAMETER:	29MM

HAND OPERATED OIL PUMP

ALUMINIUM BODY!



SUCTION DISTANCE:	1.5M
LIFT DISTANCE:	5M
FLOW RATE:	22 L/MIN
ROTARY RATE:	60
OUT DIAMETER:	32MM
INNER DIAMETER:	25MM



PORTABLE TESTING PUMP

5MPA

The test and pressure:
0-50bar, 1bar first-level,
0-725psi, 20psi are first-level,
0-5Mpa, 0.1Mpa is first-level.
Box capacity 12 liter.
Self-absorption abilities.
Approximately the 45ml/stroke.



AIR COMPRESSOR

DC12v air compressor design with easy carry handle. 30mm x 2 cylinder. Metal gauge. With LED. With small feet to keep stable, smaller noise when working. With air hose and cord storage.

AIR COMPRESSOR

DC 12v new small metal compressor design with easy carry handle. 30mm cylinder, 3-4 minutes to inflate normal car tire as well as the small truck. Metal gauge. For car motorcycle, small truck. With small feet to keep stable, small noise when working. With air hose and cord storage. Rating power:140W.



AIR ERUPT INFLATOR EU-AC024V

AIR ERUPT INFLATOR

Power supply:DC12V.
Rated current:16A.
Cylinder diameter: 32mm.
Max pressure: 150PSI.
Max duty cycle: 20 minutes.



AIR ERUPT INFLATOR

Power supply:DC12V.
Rated current:30A.
Max. Pressure:150PSI.
2 x 30mm cylinder.
2.4M cord with battery clips.
5M PU hose.



DC 12V air compressor design with metal handle. With 30mm metal cylinder, 3-4 minutes to inflate normal car tire, it can inflate for middle bus and small truck as well. 5 pcs LED working light (2 pcs blinking red, 3pcs blinking white) used for illumination and flashing. With the battery of the LED used at emergency condition. With small feet to keep stable, smaller noise when working.



DC 12V air compressor design with metal handle. With 30 mm x2 metal cylinder, 2-3minutes to inflate normal car tire, it can inflate for middle bus and small truck as well. 5 pcs LED working light (2 pcs blinking red, 3pcs blinking white) used for illumination and flashing. With the battery of the LED used at emergency condition. With small feet to keep stable, smaller noise when working.



7 PCS HIGH GRADE BODY REPAIR KIT

For pounding auto sheet metal before finishing.
Use on flat & curved surfaces.
Includes 3 hammers and 4 dollies.



7 PCS HIGH GRADE BODY REPAIR KIT

For pounding auto sheet metal before finishing.
Use on flat & curved surfaces.
Includes 3 hammers and 4 dollies.



GRINDING WHEEL-4PCS

Max:2000m/min
Size:
300X32X32mm
250X25X32mm
200X25X32mm
160X20X32mm



GRINDING WHEEL-4PCS

Max:2000m/min
Size:
250X25X32mm
200X25X32mm
150X20X32mm
125X20X25mm



FLEXI-WHEEL SET FOR ANGLE GRINDER

40grit,60grit, 80grit,100grit,120grit



SHARPENING STONE

110X55XM14
C36R
50M/s
8700/min

DIAMOND TURBO GRINDING WHEEL



∅ 115mm
∅ 22.2mm



∅ 115mm
∅ 22.2mm

DIAMOND CONTINUOUS GRINDING WHEEL

DIAMOND TURBO GRINDING WHEEL

∅ 180mm
∅ 22.2mm



∅ 180mm
∅ 22.2mm



TWISTED CUP BRUSH 4"xM14

Wire Size: ∅0.5mm
Cup Size: ∅100mm
Nut Size: M14 x 2
For deburring, removing rust,
for cleaning surfaces.....

8500rpm



ALUMINIUM OXIDE SHARPENING STONE

Size:6"
Grit:120/240



ALUMINIUM OXIDE SHARPENING STONE

Size:8"
Grit:120/240



TILE CUTTING WHEEL



BENCH VICE

Fixed with anvil type

SIZE	WIDTH OF JAWS
3"	75mm
4"	100mm
5"	125mm
6"	150mm
8"	200mm



BENCH VICE

Swivel with anvil type

SIZE	WIDTH OF JAWS
3"	75mm
4"	100mm
5"	125mm
6"	150mm
8"	200mm

WELDING EARTH CLAMP

HOLLAND TYPE

Exterior polished.
Nickle plated.

- 300AMP
- 400AMP
- 500AMP
- 600AMP



G CLAMP

Heavy-duty malleable steel frames.
Hot forged and heat treated for maximum strength.
Hardened tip to withstand stress easily.
Sliding T-bar handle.
Size: 2", 3", 4", 5", 6", 8", 10", 12".



F CLAMP

Size:
80x250mm
100/120x200mm
80/100/120x300mm
100/120x400mm
100/120x500mm
100/120x600mm
100/120x800mm
100/120x1000mm
100/120x1200mm

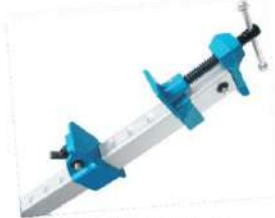

T BAR CLAMP

Size:
24", 32", 36", 40", 48", 60", 72".

HAND PIPE THREADER DIE TOOL SET

5 popular interchangeable sized cutting dies.
Ratchet head with two piece handle.



PIPE DIE SET

Designed for industrial use.
4 chasers & 4 waste holes per head for clean accurate cutting & swarf dispersal.
Grips designed for comfort, safety and utility.



HAND RIVETER

Designed for industrial use.
Lever design reduces physical strength for all rivet sizes.
Grips designed for comfort, safety and utility.



INSPECTION LAMP

DC, 12V



INSPECTION LAMP

220-240V AC



INSPECTION LAMP

AC, 60W



METAL JERRY CAN

STRONG, STURDY & DURABLE CONSTRUCTION.
CORROSION RESISTANT.



2 JAWGEAR PULLER

Drop-forged, Heat treated for added strength and chrome plated to resist corrosion.
Swivel thrust plates on larger sizes prevent damage to shaft ends.
Hex head forcing screws suitable for use with alchet wrench or combination spanner.

6"	25~160mm, heavy duty
4"	50~320mm, heavy duty



3 JAWGEAR PULLER

3"	15~80mm, heavy duty
4"	20~120mm, heavy duty
6"	25~160mm, heavy duty
8"	30~210mm, heavy duty
10"	40~260mm, heavy duty
12"	50~320mm, heavy duty

PISTON RING COMPRESSORS
1/4" DRIVER KEY

Quick release button.
Made of good quality spring steel.
Operated by the 1/4" drive key.
Application range:
3" 53-175mm,
4" 53-175mm,
6" 60-175mm.



HEAVY DUTY HAND RIVETER

Composite hand grips with spanner storage.
Four nozzles to accept 2.4mm(3/32"), 3.2mm(1/8"),
4.0mm(5/32") and 4.8mm(3/16") rivets.
Supplied with nozzle spanner.

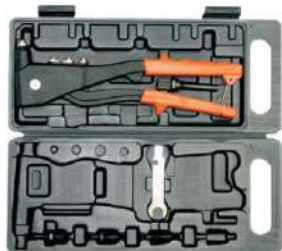

HAND RIVETER

Professional quality
Riveting size: 2.4mm (3/32") , 3.2mm (1/8"), 4.0mm
(5/32") and 4.8mm (3/16")
Single pull action designed for continuous riveting
Ergonomically designed for comfortable grip
And ease of use.
Heavy duty construction
Filment spanner



MANUAL STRAP PACKING SET

FOR PVC TAPE



This manual PVC band strapping tool is
easy to operate and easy to carry.
Size:12-16mm.

MANUAL STRAP PACKING SET

FOR PVC TAPE



Heavy duty.
This manual PVC band strapping tool is
easy to operate and easy to carry.
Size:16mm.

STAPLE GUN TACKER



Suitable for a wide variety of DIY
applications.
Safety loop on handle.

STAPLE GUN TACKER



Crown staples: 4mm-14mm leg length.
uses fine wire staples.

MANUAL STRAP PACKING SET

FOR PVC TAPE



This manual PVC band strapping tool is
easy to operate and easy to carry.
Size:16mm.

MANUAL STRAP PACKING SET

FOR PVC TAPE



Heavy duty.
This manual PVC band strapping tool is
easy to operate and easy to carry.
Size:12-16mm.

COMBINATION GLOVES

Size:10.5"



RED WELDING GLOVE



GREY WELDING GLOVE



BLACK WELDING GLOVE



COMBINATION GLOVE

6LBS MAGNETIC PICK-UP TOOL



Chromed metal body with
pocket-clip for safe storage.
Powerful magnet
with 2 lbs capacity.
Telescopic shaft extends
from 13 cm to 64 cm.
High visibility handle so it
can easily be found.



24V BATTERY TESTER
Digital display

For cars, light trucks,
garden tractors, R.V.S
LX2021



6/12V BATTERY TESTER
Digital display

For cars, light trucks,
garden tractors, R.V.S
LX511



12V BATTERY TESTER
Digital display

For cars, light trucks,
garden tractors, R.V.S
LX502



PROFESSIONAL BATTERY TESTER

Fit for cars, vans, RVs and farm vehicles

Test condition of 6V/12V lead acid battery
compact & portable, ideal for garages and fleet users
testing can be done with engine on most vehicles
heavy duty insulated clamp
easy & safe to use, no sparking

HUG LIGHT



Versatile light for easier reading, especially in the dark. Bend into a hook or cobra-shape & it becomes a hanging or stand up light.



110PCS HYDRAULIC GREASE NIPPLE SET

Size: 30pc straight 1/4"-28, 15pc 45° 1/4"-28, 15pc 90° 1/4"-28, 15pc 90° 1/8" NPT, 15pc 45° 1/8" NPT.

419 PCS METRIC O RING ASSORTMENT KIT

For use in plumbing, hydraulics, ir and gas connections. Ideal for shop, garage or workplace



STEP LADDER WITH TRAY

Easy open, easy closed. Skid resistant feet.



STEP LADDER WITH TRAY

Easy open, easy closed. Skid resistant feet.



CAMLOCK & GROOVE COUPLING



A TYPE



B TYPE



E TYPE



DP TYPE



C TYPE



D TYPE



F TYPE



DC TYPE

CABLE REEL

50 metre 3 outlets socket
H05VV-F 3GX0.75QMM
250V/50HZ
50M



3 SOCKET

25 metre 3 outlets socket
H05VV-F 3GX0.75QMM
250V/50HZ
25M



3 SOCKET

50 metre 4 outlets socket
H05VV-F 3GX0.75QMM
250V/50HZ
50M



4 SOCKET

ALUMINUM WELDING WIRE

ALLOY	SPECIFICATION	DIAMETER	MANUFACTURE MODE									
			EXTRUSION	DRAWING								
9358	9.8MMx0.85u	Ø 8.5MM	✓	✓								
CHEMICAL COMPOSITION												
	Fe	Si	Cu	Mg	Mn	Zn	Ni	Cr	Ti	Zr	Bi	Pb
	0.04	0.25	0.15	4.4	0.08	0.1	0.05	0.28	—	—	—	—
MECHANICAL PROPERTIES												
	TENSILE STRENGTH	ELONGATION	HARDNESS									
	330-340	5	95									

PRODUCTS	TYPE		DIAMETER
	CONSTRUCTION	APPLICABLE	
ALUMINUM	3	3	Ø 8.5MM
COPPER	3	3	Ø 8.5MM



SOLDERING IRON

30,40,60,80,
100,150,200,
300,500W



ALLOY	SPECIFICATION	DIAMETER	MANUFACTURE MODE									
			EXTRUSION	DRAWING								
9358	9.8MMx0.85u	Ø 8.5MM	✓	✓								
CHEMICAL COMPOSITION												
	Fe	Si	Cu	Mg	Mn	Zn	Ni	Cr	Ti	Zr	Bi	Pb
	0.04	0.25	0.15	4.4	0.08	0.1	0.05	0.28	—	—	—	—
MECHANICAL PROPERTIES												
	TENSILE STRENGTH	ELONGATION	HARDNESS									
	330-340	5	95									

PRODUCTS	TYPE		DIAMETER
	CONSTRUCTION	APPLICABLE	
ALUMINUM	3	3	Ø 8.5MM
COPPER	3	3	Ø 8.5MM

HYDRAULIC BOTTLE JACK

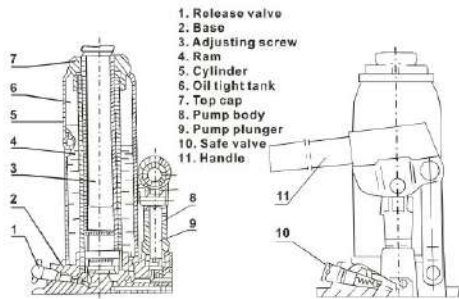

1. Release valve
2. Base
3. Adjusting screw
4. Ram
5. Cylinder
6. Oil tight tank
7. Top cap
8. Pump body
9. Pump plunger
10. Safe valve
11. Handle

CAUTION

- * Never exceed the jack's rated load capacity
- * Base of jack should always rest on a firm, level surface
- * Never work under the lift load without additional support devices

Application:

The jacks work in accordance with the hydraulic principle. The feature is compactness, small, light and portability, They are widely used in automobiles and tractors.

The jacks are suitable only for vertical lifting jobs. The range of ambient temperature at which the jacks can be used is from +55°C to -20°C. They should not be used in places where acid, alkali or other corrosive gases exist. The jacks can be used in explosive atmosphere.



4 TON HYDRAULIC BOTTLE JACK 6 TON HYDRAULIC BOTTLE JACK 8 TON HYDRAULIC BOTTLE JACK 10 TON HYDRAULIC BOTTLE JACK 12 TON HYDRAULIC BOTTLE JACK



16 TON HYDRAULIC BOTTLE JACK 20 TON HYDRAULIC BOTTLE JACK 32 TON HYDRAULIC BOTTLE JACK 50 TON HYDRAULIC BOTTLE JACK

HAND OPERATED VERTICAL HYDRAULIC JACK



2T

CAPACITY	N.W.	MIN HEIGHT	LIFTING HEIGHT	ADJUST HEIGHT
2 TON	2.2kg	150mm	100mm	60mm



3T

CAPACITY	N.W.	MIN HEIGHT	LIFTING HEIGHT	ADJUST HEIGHT
3 TON	2.3kg	150mm	100mm	50mm

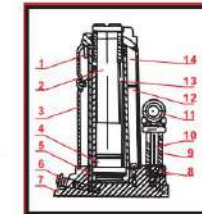

1. TOP CAP
2. ADJUSTING SCREW
3. OIL TIGHT TANK
4. RAM HEAD
5. CIRCLE SEAL
6. RELEASE VALVE
7. BASE
8. CIRCLE SEAL
9. PUMP BODY
10. PUMP PLUNGER
11. PUSH HANDLE
12. HYDRAULIC OIL
13. RAM
14. CYLINDER



5T

CAPACITY	N.W.	MIN HEIGHT	LIFTING HEIGHT	ADJUST HEIGHT
5 TON	3.3kg	150mm	100mm	50mm



8T

CAPACITY	N.W.	MIN HEIGHT	LIFTING HEIGHT	ADJUST HEIGHT
8 TON	4.2kg	150mm	100mm	50mm



10T

CAPACITY	N.W.	MIN HEIGHT	LIFTING HEIGHT	ADJUST HEIGHT
10 TON	5.0kg	200mm	120mm	50mm



15T

CAPACITY	N.W.	MIN HEIGHT	LIFTING HEIGHT	ADJUST HEIGHT
15 TON	8.4kg	220mm	140mm	80mm



20T

CAPACITY	N.W.	MIN HEIGHT	LIFTING HEIGHT	ADJUST HEIGHT
20 TON	10.5kg	220mm	140mm	60mm



32T

CAPACITY	N.W.	MIN HEIGHT	LIFTING HEIGHT	ADJUST HEIGHT
32 TON	18.5kg	350mm	180mm	—



TROLLEY JACK,
LONG BODY

MODEL: 3TON
MODEL: 5TON
MODEL: 10TON
MODEL: 20TON

3000kgs LAUFKATZE HEBER
3TONNE TROLLRY JACK

CAPACITY TONNE	MINIMUM HEIGHT	HYDRAULIC LIFT	NETT WEIGHT
3	12cm	36.3cm	34kgs



16 TON HYDRAULIC PIPE BENDER

Bends 6 different diameter pipes from 1/2"to3"
Bending bars can be adjusted to distance of 8-1/2",11-1/2",14-1/2",17-1/4",20-1/2"and23-1/2"
Steel frame is 25-1/2"wide,5"deep x23"high
Bend up to 180 degrees
Jack capacity:12-1/4"minimum,22-1/2"maximum,10-1/4"stoke



12 TON HYDRAULIC PIPE BENDER

Bends 6 different diameter pipes from 1/2"to2"
Bending bars can be adjusted to distance of 7-3/4",10-1/2",13-1/2",16-1/4",19"and22"
Steel frame is 23-1/2"wide,5"deep x20-1/4"high
Bend up to 180 degrees
Jack capacity:12-1/2"minimum,22-3/4"maximum,10-1/4"stoke



**HYDRAULIC AUTO BODY REPAIR KIT
10TON**

Pump hydraulic hose cylinder hydraulic spreader base
spreader ram on jack circular plunger square plunger
wedge plunger spherical plunger plate plunger
moveable connection shaft tube

**HYDRAULIC AUTO BODY REPAIR KIT
IN METAL BOX
10TON**

VG0215



HYDRAULIC AUTO BODY REPAIR KIT

VGMARBR15



HYDRAULIC AUTO BODY REPAIR KIT

VGMARBR20-1
20TON



**HYDRAULIC
AUTO BODY
REPAIR KIT**

VGMARBR20-2 20TON



SACK TRUCK



HAND TRUCK

ITEM/TYPE	DF20 2000		DF26 2500		DF30 3000		DF40W 2000	
Capacity(kg)	2000		2500		3000		2000	
Min.fork height(mm)	85	75	85	75	85	75	81	81
Max.fork height(mm)	200	190	200	190	200	190	270	260
Steering Wheel(mm)	Ø200×90	Ø180×140	Ø200×90	Ø180×140	Ø200×140	Ø200×90	Ø200×90	Ø200×90
Load roller (mm)	Single	Ø80×90	Ø12×90	Ø80×90	Ø74×90	Ø80×90	Ø80×90	Ø50×90
	Tandem	Ø80×70	Ø74×70	Ø80×70	Ø74×70	Ø80×70	Ø80×70	Ø50×70
Size of fork(mm)	160×90		160×90		160×90		160×90	
Width overall forks(mm)	450/200/500/600						450/200/500	
Fork length(mm)	800/900/1600/1067/1190/1150/1220						800/900/500	



HAND STACKER

ITEM/TYPE	SFH10	SFH15	SFH10
Capacity(kg)	1000	1500	1000
Min.fork height(mm)	85	85	85
Max.fork height(mm)	1600	1600	1600
Min.mast height(mm)	1900	1900	2500
Size of fork(mm)	150/160×60	150/160×60	1800
Length of fork(mm)	900/1150	300/1150	900/1150
Width overall forks(mm)	330-740/550	300-740/550	300-740/550
Radius of gyration(mm)	1250/1380	1250	1260/1000
N.W.(kg)	240/220	260	300
Fork rolls(mm)	Ø 74×70	74×70	74×70
Big wheel(mm)	Ø 1850×50	1800×50	1800×50

HAND PULLER 1 TON

Drop forged steel hooks.
All steel construction.
2000lb pulling capacity and 1000lb lifting capacity.
Comfortable grip handle.



HAND PULLER 2 TON

Drop forged steel hooks.
All steel construction.
4000lb pulling capacity and 2000lb lifting capacity.
Comfortable grip handle.



HAND PULLER 3 TON

Drop forged steel hooks.
All steel construction.
6000lb pulling capacity and 3000lb lifting capacity.
Comfortable grip handle.



HAND PULLER 4 TON

All steel zinc plated.
3 hooks.
Max. Cable length:3m.
Cable diameter:6mm.
Comfortable grip handle.



WIRE ROPE PULLING HOIST
wire rope: 16mm
model: 3.2 TON



HOSE HANGER



PIPE BENDER



2 TON HYDRAULIC ENGINE CRANE



3 TON HYDRAULIC ENGINE CRANE

Heavy steel construction for maximum durability
Wide base for maximum stability
Heavy duty steel hook with safety latch
Telescopic boom provides 4 positions



2 TON HYDRAULIC ENGINE CRANE

Heavy steel construction for maximum durability
Wide base for maximum stability
Heavy duty steel hook with safety latch
Telescopic boom provides 4 positions

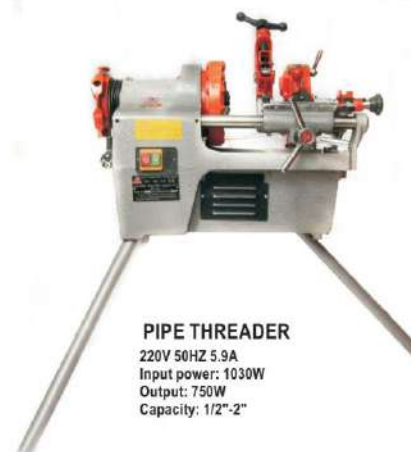

PIPE THREADER
220V 50HZ 5.9A
Input power: 1030W
Output: 750W
Capacity: 1/2"-2"



FLOOR GRINDING MACHINE



HYDRAULIC PRESSING MACHINE

- AE010A01
- AE010A03
- AE010A04
- AE010A05

12 TON 20 TON 30 TON 50 TON



TROLLEY JACK

- VG01K9007
- with Quick Lift foot Pedal
- Min. Height - 135mm
- Max. Height - 525mm

3 TON



AIR BOTTLE JACK

- MIN.H: 260MM
- MAX.H: 490MM

12 TON 20 TON



HYDRAULIC BODY REPAIR KIT

10 TON



TROLLEY JACK

3 TON

100-530mm

- AE011A01
- AE011A02
- AE011A03

JACK STAND

3 TON 6 TON 12 TON



SCISSOR JACK 2 TON

- Min.h:105mm
- Max.h:380mm

2 TON



AIR BOTTLE JACK

- MIN.H: 280MM
- MAX.H: 440MM

50 TON



AIR TROLLEY JACK

- Min.h:225+20mm
- Max.h:435+100mm
- Adjust.h:80mm
- Lifting.h:130mm

22 TON



TROLLEY JACK KIT

- + Wheel Chocks
- + Work Gloves
- + Knee Pad

2 TON



ELECTRIC JACK

- Rates load: 2000kg
- Voltage: 13V
- Max current: 13A
- Rated power:150W
- Jacking height: 12cm-35cm

2 TON



MECHANICAL JACK

- MIN.H:80MM
- MAX.H:730MM
- N.W:27KGS
- MIN.H:85MM
- MAX.H:800MM
- N.W:46.5KGS

5 TON

10 TON



HYDRAULIC LIFTING BY FOOT PEDAL

- Lower by handwheel
- Sturdy, ball bearing, steerable wheels
- 360 degrees rotatable
- Material: tool steel
- Steel rollers
- Up to 500 kg load capacity
- Adjustable height between 1000 and 1900 mm

0.5 TON

HYDRAULIC HAND PALLET STACK

- Max.Lifting Height: 1600mm
- Max.Fork Height 1600mm
- Max.Lifting Height 1600mm
- Fork Outside Distance 600mm
- Fork Length 1070mm
- Total Height 2011mm
- Total Length 1255mm
- Body width 700mm
- Load Roller Tandem Wheel 460x80mm
- Clearing Wheel 470x50mm
- Weight of Wheel 2000kg
- Capacity 255kg

2000 KG

ELECTRIC CAR HYDRAULIC FLOOR JACK /TIRE INFLATOR GAUGE /IMPACT WRENCH

1.5 Ton Capacity 450mm x 155mm 3 in 1





WT04H0022

**MINI AIR COMPRESSOR
2 CYLINDER/PUMP**

- Max air flow: 300L/min
- 2m cord with battery clamps
- Automatic reset thermal protection
- Steel pressure gauge



BD05

**2 CYLINDER
MINI AIR COMPRESSOR**

- Max Amperage: 25A
- Duration: 12-15Min
- Max pressure: 10kg/cm² (150PSI)
- Displacement: 70 L/min

DC
12V
13.8V
150PSI



**ELECTRONIC
PLATFORM SCALE**



**ELECTRONIC
PLATFORM SCALE**



RA89

RA90

DIAL PLATFORM SCALE

- 300KG/500G PLATE: 45*60CM
- 500KG/1000G PLATE: 45*60CM

RA92

**DOUBLE DIAL
PLATFORM SCALE**

- 100KG/200G PLATE: 30*40CM



KDA-3

KDA-3

DIGITAL KITCHEN SCALE

- 3KGS/5KGS



PL-H

LUGGAGE SCALE

- 50KGS



KDB-2

DIGITAL KITCHEN SCALE

- 3KGS



ACS-1

ACS-1

WEIGHING & COUNTING SCALE

- 15KGS/30KGS



KDF

DIGITAL KITCHEN SCALE

- 5KGS



WT6620310

RA93

RA98

**SPARE DIAL SCREEN
WITH VERTICAL COLUMN
DOUBLE DIAL PLATFORM SCALE**

- 500KG/1000G
- 150KG/500G
- 200KG/500G

**FOLDING LADDER YELLOW
WITH FIBERGLASS FRAME INSULATED**

WT01J0122

- No. of step: 2*4
- Extended height: 107cm
- Spacing between rungs: 30cm
- Load: 150kg
- Net weight: 5.6kg

WT01J0123

- No. of step: 2*6
- Extended height: 164cm
- Spacing between rungs: 30cm
- Load: 150kg
- Net weight: 7.8kg

WT01J0124

- No. of step: 2*8
- Extended height: 221.5cm
- Spacing between rungs: 30cm
- Load: 150kg
- Net weight: 10.9kg

WT01J0125

- No. of step: 2*10
- Extended height: 279cm
- Spacing between rungs: 30cm
- Load: 150kg
- Net weight: 13.8kg



**ALUMINUM ALLOY
FOLDING LADDER
4 STEPS & 5 STEPS**



**MULTI PURPOSE
ALUMINUM LADDER**

- The working platform, lean-to ladder and step ladder in one
- 6 safety joints for locking/releasing the ladder sections
- Non-slip, ribbed rungs
- High variability of use
- Step Height: 29cm

16
steps
480cm

20
steps
600cm



ED002A04

**ALUMINUM LADDER
FOLDING**

- Telescopic ladder:
- 2.5m+2.5m=5.0m (Open length)
- Steps: 16
- MAX loading: 150kgs



DSZ3-A02X

AUTOMATIC LEVEL

- Measuring Accuracy: ±2.5mm/km
- Magnification: 32X
- Objective aperture: 36MM
- Minimum Visual distance: 0.8MM
- Angular dimension of the round vial: 8'2mm
- Angle division: 360°



WT01M0151

WT01M0152

LASER DISTANCE

- Meter SW-50
- Meter SW-100



HW005A17
46PC SOCKET SET
 • 13pcs 1/4" socket
 • 21 pcs bits socket
 • 1 pes 1/4", universal joint
 • 1 pc 1/4" ratchet handle 72T
 • 1 pc sliding bar 115mm
 • 1 pc spinner handle 150mm
 • 1 pc flexible extension bar 150mm
 • 1 pc 1/4" hex bit adaptor 30mm
 • 2pcs 1/4" extension bar: 50 mm & 100 mm
 • 4pes hex key wrench: 1.27, 1.52, 2.5mm



WT01T0013
111PCS 1/4\"&1/2\" DRIVE SOCKET SET
 • Matte finishing
 • Chrome Vanadium Steel
 • 1/2" drive



HAM
96PC SOCKET SET
 • 1/2" DRIVE
 • 18pcs 1/2" socket
 • 4pcs 1/2" deep socket
 • 1 pes 1/2", universal joint
 • 2pcs 1/2" extension bar: 125 mm & 250 mm
 • 1pc 1/2" ratchet handle 72T
 • 1 pc 1/2" 3 way adaptor
 • 2pcs 1/2" spark plug socket: 16 & 21 mm

• 1pc 1/2" bits holder 5/16"
 • 15pcs bits 30mm
 • 1/4" DRIVE
 • 13pcs 1/4" socket
 • 1 pc sliding bar 115mm
 • 1 pc spinner handle 150mm
 • 1 pc flexible extension bar 150mm
 • 3pcs hex key wrench
 • 1 pc 1/4" hex bit adaptor 30mm
 • 17pcs bits socket:
 • 1 pes 1/4", universal joint
 • 2pcs 1/4" extension bar: 50 mm & 100 mm
 • 1pc 1/4" ratchet handle 72T



WT01 T0051
219PCS 1/4\" 3/8\"&1/2\" DRIVE SOCKET SET
 • CRV Material
 • Matte finishing



HW002A54
111PCS 1/4\"&1/2\" DRIVE SOCKET SET
 • 36-80MM (1" DRIVE, 6 POINTS)



SPANNER SET
 • Diring 6-32mmx12pcs
 • D/open 6-32mmx12pcs
 • Combination 6-32mmx12pcs

HW004A36 HW007A24 HW003A45



TARGET COMBINATION SPANNER

• Size: 6 8 9 10 11 12 13 14 15 16 17 18
 19 21 22 23 24 25 26 27 28 29 30 31 32
 33 34 36 37 38 39 40 41 42 43 44 45 50
 55 57 60 65 70 75 80 85mm

HW003A13 HW003A14
 HW003A15 HW003A16



DOUBLE RING SPANNER
 CRV MATERIAL, CHROME PLATED

• Size: 10" 11, 14" 15, 16" 17, 24" 27

HW004A13 HW004A15 HW004A16 HW004A20



HPA03
3" DRILL PRESS VISE

HPA04
4" DRILL PRESS VISE

HPA05
5" DRILL PRESS VISE

HPA06
6" DRILL PRESS VISE



WT01P0023
8IN. PRUNING SHEARS WITH STAINLESS STEEL BLADES

• Zinc alloy body
 • Stainless steel cutting edges
 • Sturdy leaf spring for easy cutting
 • Strong clip for safe storage
 • Soft grip handle



HC002A05V
PRUNING SHEARS - 8IN WITH WOOD HANDLES

8 Inch
 With Wooden Handle



WT01C0131
TARGET MACHINIST HAMMER FIBER HANDLE 100G

VG002A07
GARDEN SHEARS

• Tubular steel handles with cushion soft grips for maximum comfort and ease of use
 • Hardened and tempered carbon steel blades
 • By-pass cutting action
 • Easy to use twist handles



WT01M0153
ELECTRONIC THEODOLITE

• Raster Diameter: 79mm
 • Min Display Unit 1"/5" Selectable
 • Effective Aperture 45mm
 • Magnification: 30x
 • Minimum Focusing Distance: 1.4m
 • Type: Lcd Display 2 Sides
 • Voltage: Dc 6v



MAGNETIC DRILL BIT FOR MAGNETIC DRILL

• 12MM, 14MM, 16MM, 18MM, 20MM, 22MM, 24MM, 26MM, 28MM, 30MM, 32MM

WT01S0068 WT01S0069 WT01S0090
 WT01S0064 WT01S0062 WT01S0063
 WT01S0064 WT01S0065 WT01S0066



MAGNETIC DRILL ADAPTOR

• 40CR.GUIDE LENGTH 75MM 23MM-2#/28MM-3#

WT01S0097 WT01S0098



VG1001
STORAGE RACK WITH 16PCS BIN



F CLAMP

- 80x250mm
- 100/120x200mm
- 80/100/120x300mm
- 100/120x400mm
- 100/120x500mm
- 100/120x600mm
- 100/120x800mm
- 100/120x1000mm
- 100/120x1200mm

- WT01H0005
- WT01H0006
- WT01H0007
- WT01H0013
- WT01H0008
- WT01H0014
- WT01H0025
- WT01H0009
- WT01H0015
- WT01H0016

JERRY CAN Material:PE

- WT01Z0720
- Capacity: 20L(5.3Gal)
- Exterior dim: 331*187*454mm
- WT01Z0724
- Capacity: 5L(1.3Gal)
- Exterior dim: 235*156*251mm
- WT01Z0725
- Capacity: 10L(2.6Gal)
- Exterior dim: 300*187.6*285mm



HIGH QUALITY JERRY CAN

- WT01Z0434
- 5L/0.6MM thickness
- WT01Z0102
- 10L/0.8MM thickness
- ATC20A66
- 20L/0.8MM thickness

- WT01H0015
- WT01A1204
- HC005A01
- HC005A02
- HRA132
- HRA133



INDIVIDUAL ROUTER BIT

- HX007A33
- CORNER ROUND 1/2"X8MM
- HX007A34
- CORNER ROUND 1/4"X8MM
- HX007A35
- CORNER ROUND 3/8"X8MM

T BAR CLAMP CAST IRON CLAMP

- 24" 36" 48"
- 60" 72" 84"



BIT SLOT CUTTER YG8 HEAD, 8MM SHANK

- HX007A21
- Size: 1-1/4"x3/8"
- HX007A22
- Size: 1-1/4"x1/2"
- HX007A32
- Slot cutter 3/8"x8"
- HX007A30
- Slot cutter 1/2"x8"
- HX007A31
- Slot cutter 5/16"x8"
- WT08C021B
- Slot cutter 8x1/4"

DRILL CHUCK

High carbon steel Hardened and tempered

- ES001A68
- 1.5-13mm
- (thread type, with key) in blister pack
- ES001A61
- 5-20mm
- (Taper type, with Key) in Colour box
- WT08F0025
- 3-16mm
- (tapper type, with key)

- ES001A60
- 3-16mm
- (tapper type, with key)
- ES001A61
- 5-20mm
- (tapper type, with key)

- C 90



7HP PLATE COMPACTOR



TAMPING RAMMER

- WT08B0036
- Single cylinder, air-cooled 4 stroke, OHV
- Leap Height: 40 ~ 65 mm
- Tamping Force: 10.0KN
- Tamping Frequency: 450 ~ 650 times/min
- Plate size: 300*310 mm
- Net Weight: 78kgs



CUP WIRE BRUSH

- Size: 100mm *M14
- Size: 65mm *M14
- Size: 75mm *M14
- WT01K0047



WHEEL BRUSH

- Size: 100mm 4 inch
- Size: 125mm 5 inch
- Size: 150mm 6 inch
- Size: 200mm 8 inch
- WT01K0043



WHEEL BRUSH - CRIMPED MODEL

- WT01R6133
- Size: 200mm 8 inch



- WT03F0002

- AIR IMPACT WRENCH**
- 3/4"
- 25PCS.

- WT03F0003

- AIR IMPACT WRENCH**
- 1/2"

- WT03F0005

- AIR IMPACT WRENCH**
- 17pcs
- 1/2" impact wrench kit

- WT03F0004

- AIR IMPACT WRENCH**
- 14pcs
- 3/4" impact wrench kit



AIR POLISHER 7"

- WT03C0011
- Freespeed: 2.800 r.p.m
- Air Consumption(25%): 6.00scfm
- Exhaust: Bottom
- Length: 330mm
- Weight: 2.2kgs/4.8lbs
- Air pressure: 90psi
- Air Inlet: 1/4"



- WT03F0019

AIR RATCHET

- Free Speed: 160r.p.m
- Max.torque: 45 Ft.lbs/61nm
- Air Consumption(25%): 5.25scfm
- Exhaust: Front
- Length: 265mm
- Weight: 1.2kgs/2.6lbs
- Air pressure: 90psi
- Air Inlet: 1/4"



AIR PAVING BREAKER

- ER008A01
- Pressure: 0.63mp
- Impact power: 1.8kw
- Impact energy: 100J
- Blows frequency: 18hz
- Inner air pipe size: 19mm

- WT03A0003

- Industrial quality,
- With 3/4" air inlet,
- Inner air pipe size: 19mm,
- With 1pc point chisel
- N.W.: 21.5KGS

- WT03A0004

- Industrial quality,
- With 3/4" air inlet,
- Inner air pipe size: 19mm,
- With 1pc point chisel
- N.W.: 18KGS

60 PCS



METRIC & SAE TAP AND DIE SET

HD003804

- Dies 27pcs In Following Size
- Taps 27 Pcs In Above Size as Die's Size
- 1 Pc Die Handle
- 1 Pc Tap Wrench
- 1 Pc T-type Tap Wrench
- 2pcs Screw Pitch Gauge
- 1 Pc Screwdriver

52 PCS



METRIC & SAE TAP AND DIE SET

HD003802

- Dies 12pcs In Following Size
- Drills 12pcs In Following Size
- 1 Pc Die Handle
- 1 Pc Tap Wrench
- 1 Pc T-type Tap Wrench
- 1pc Screwdriver

65 PCS



METRIC & SAE TAP AND DIE SET

HD003806

- Dies 28pcs In Following Size
- Taps Each 13 Pcs In Above Size. As Die's Size
- 4pc Tap Wrench
- 7pc Die Handle
- 1 Pc Screwdriver



HIGH-SPEED PEDAL SEALER

VIT220088

- Highly reliable and durable
- Wire sealer, seal and cut in one step.
- 700mm/500mm 850w
- W/foot pedal

700MM 500MM



7 DRAWERS METAL TOOL TROLLEY

WT01Y906

- Frame thickness: 0.7mm,
- Drawer thickness: 0.7mm
- 7pcs drawer with ball bearing slide
- 7pcs Drawer size:
5pc-535*395*65mm
2pc-535*395*140mm
- 4pcs heavy-duty castors



7 DRAWERS ROLLER CABINET

WT01666S

- 5 small drawers, W535*D400*H55MM
- 1 medium drawers, W535*D400*H125MM
- 1 large drawers, W535*D400*H195MM
- Plastic worktop
- Stainless steel workop
- Casters: 125mm diameter



7 DRAWERS ROLLER CABINET WITH 196PCS TOOL KITS BMC TRAY

WT01163

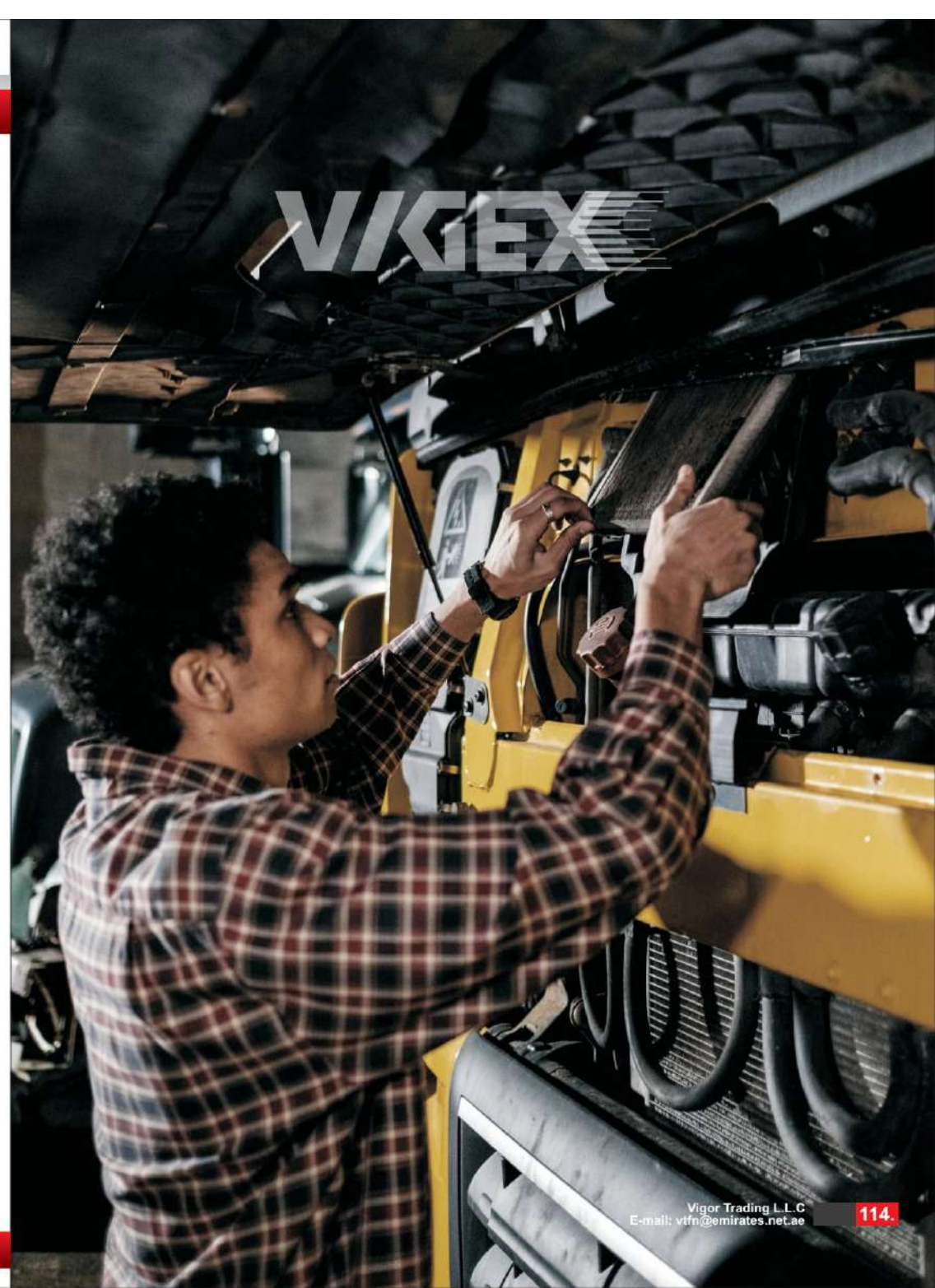



AT020A100

CAR CREEPER 36"

- Size 90*42*12cm
- Hdpe material
- Black pillow
- 6pcs 2.5" swivel castors



TD191754

DIESEL ELECTRIC FUEL TRANSFER PUMP OIL DISPENSER

- Voltage:12V
- Power:175W
- Load current:10Amps
- Inlet diameter :25mm
- Outlet diameter :25mm
- Flowing:45L/min



TD191752

DIESEL ELECTRIC FUEL TRANSFER PUMP OIL DISPENSER

- Voltage: DC 12V
- Power: 175W
- Load current: 10Amps
- Speed: 3600RPM
- Flowing: 45L/min
- Inlet/Outlet diameter: 25mm



TD190500

ELECTRIC DIESEL FUEL TRANSFER PUMP

- Voltage: 230V
- Rated frequency: 50Hz
- Rated Power: 550W
- Speed: 2800RPM
- Max. Flowing: 60L/min
- Inlet/Outlet diameter: 25mm



FD191750

METERING DIESEL TRANSFER PUMP

- Voltage: DC 12V
- Power: 175W
- Load current: 10Amps
- Speed: 3600RPM
- Flowing: 45L/min
- Inlet/Outlet diameter: 25mm



FD190500

METERING DIESEL TRANSFER PUMP

- Voltage: 220V
- Rated frequency: 50Hz
- Rated Power: 550W
- Speed: 2800RPM
- Max. Flowing: 60L/min
- Inlet/Outlet diameter: 25mm



2015

BATTERY LOAD TESTER

- Fixed load current: 100amps
- 100 amp load test -for 12 volt batteries up to 1000CCA
- 50 amp load test -for 6 volt batteries up to 1000CCA
- Voltage accuracy: ±0.2V
- Test Cycle: 10 seconds per test with 1 minute cool down 3 tests in 5 minutes
- Surface treatment: powder coating



2018-1

BATTERY LOAD TESTER

- Load test capacity: 135amps,
- 500 to 1000 cold-cranking amps
- Amp setting: 135amps
- Display Meter: Analog, 0-16VDC
- Voltage accuracy: ±0.1V
- Test Cycle: 10 seconds per test with 1 minute cool down; 3 tests in 5 minutes

125 AMP BATTERY LOAD TESTER



STAINLESS STEEL SPRAYER

- Stainless steel sprayers for professional applications such as fertilizers, weed killers, pesticides, and all around use.
- Designed for easy filling and cleaning.
- Adjustable brass cone nozzle, sprays fine mist to coarse stream.
- Wide base tank helps prevent tipping over.
- Metal tanks rinse cleaner for multi-use.
- Convenient carrying strap.
- Easy pump action for quick pressurizing.



SS191806



SS191808



SS191810



SS191812



SS181816



SS191810

SAND BLAST GUN

- Tank dimensions: 12" diameter, 20" length
- Overall dimensions: 33-1/2"H X 18-3/4"L X 13"W
- Weight: 40Lbs
- Hose Length: 10FT



WTD4A5046

70L OIL DRAINER NEW MODEL

- Tank capacity:70L
- Basin capacity: 10L
- Graduated cup:10L
- Medium:lubricating oil.
- φ3.5mm collecting speed:0.8L/min
- φ4.5mm collecting speed:1.0L/min.
- φ6.5mm collecting speed:1.6L/min.
- Oil pumping needles: 5pcs
- Max. collection height: 165cm



TRANSFER PUMP NOZZLE OIL GUN



WT0620017



WT0620018



WT0620019



VGD4B160

FLARING & TUBING TOOL KITS

- Flaring sizes: 1/8", 3/16", 1/4", 5/16", 3/8", 7/16", 1/2", 5/8" & 3/4" O.D. TUBING.
- Swage size: 3/16", 1/4", 5/16", 3/8", 1/2", 5/8", 3/4" O.D. TUBING.
- Tube Cutter: 1/8" to 1-1/8" (3-28mm)
- Springs tube bender sizes: 1/4" 5/16" 3/8" 1/2"



WT04B4093A

10PCS 45° FLARING & TUBING TOOL KIT-INCH

- For hard or soft copper, aluminium, brass, thin wall steel, stainless steel, titanium and other tubing.
- 1PC Tube cutter: 3-28mm
- Size: 3/16", 1/4", 5/16", 3/8", 7/16", 1/2", 5/8"



CHAIN PIPE WRENCH

- VG01B1338
- VG01B1339
- 6"
- Handle length:1000mm
- Chain length:838mm
- 8"
- Handle length:1200mm
- Chain length:990mm
- VG01B1340
- VG01B1341
- VG01B1342
- VG01B1343



GASOLINE/PETROL BLOWER

- Model: 260
- Dimensions(LxWxH): 989*274*340
- Engine Type: 1E34FB
- Cylinder Diameter: 34mm
- Displacement: 25.4cc
- Recoil starter Fuel Tank Capacity: 0.45L
- Weight: 8kgs

**TROLLEY JACK
-3 TON QUICK LIFT**



3 ton



**FOLDABLE
TOPSIDE CREEPER**

- Adjustable From 48° To 70°

The topside creeper weight capacity:
400lbs



**AIR GREASE
BUCKET 12L**



HEAVY DUTY BENCH VICE

- BV2004HD
- Jaw Opening: 110mm
- Throat Depth: 64mm
- Anvil Size: 62x62mm
- Forming Horn: Yes
- Base Swivel Degree: 360
- Quick Spec: Jaw Width: 100mm
- 4" 8kg
- BV2006HD
- Jaw Opening: 120mm
- Throat Depth: 75mm
- Anvil Size: 62x67mm
- Forming Horn: Yes
- Base Swivel Degree: 360
- Quick Spec: Jaw Width: 125mm
- 5" 12kg
- BV2008HD
- Jaw Opening: 150mm
- Throat Depth: 95mm
- Anvil Size: 75x85mm
- Forming Horn: Yes
- Base Swivel Degree: 360
- Quick Spec: Jaw Width: 150mm
- 6" 17kg



**HIGH PRESSURE
HOSE REEL**

- WT03Z0024
- WT03Z0024A
- WT03Z0024B
- 3/8" 15M
- 1/2" 15M
- 3/4" 15M

ALUMINIUM&STEEL FLOOR JACK



3 ton



**HYDRAULIC FLOOR JACK
-ALUMINIUM LOW PROFILE**



3 ton



TRANSMISSION JACKS

- Up to 500kg load capacity
- Adjustable height
- between 885 and 1760mm

0.5 ton



OIL PUMP 940MM

WT03Z0716



GREASE PUMP 940MM

WT03Z0716



AIR DUSTER GUN

- 80mm long nozzle



TRIPOD STAND

- The maximum working height: 1600mm
- Minimum height: 940mm
- The height: 950mm
- Texture of material
- Pipe diameter: 38mm
- Weight: 2.5KG



MACHINERY FLOW METER

- Material: Aluminum
- Connections: BSPF
- Medium: Diesel, Kerosene, Gasoline
- Flowrate: 0-120L/Min
- Metric Accuracy: ±1%
- Accumulative Counting Digit: 8digits



ELECTRON FLOW METER

- Outlet&inlet Size: 1"
- Measuring Accuracy: ±1%
- Repeatability: ±0.5%
- Max Working Pressure: 20bar
- Working Voltage: 2.3-3.3v
- Flow-rate Range: 10-120l/min



**110PCS HYDRAULIC
GREASE NIPPLE SET**

RA11



**PLASTIC SEALER
WITH CUTTER**

- 200mm aluminium housing.
- 300mm aluminium housing.

WT04A509T

WASTE OIL CONTAINER 30L

- Diameter for Funnel: 43cm, with filter screen.
- Material for Adjustable pipe: Aluminium, 5cm Dia
- 4pcs oil resistant pvc castors
- Oil temperature range from -30°C to 80°C
- Tank capacity: 8 gallon (30 Liter)
- Collection Funnel capacity: 4 gallon (15 Liter)
- Min collection height: 27in (69cm)
- Max collection height: 68.9in (175cm)



VG02J104R

FUEL INJECTOR CLEANER & TESTER

- Fuel tank capacity: 2.4L
- Test tube capacity: 120ML
- System flow: 4L/min
- System pressure: 0-5.5kg/cm²
- Working temperature: +5°C ~ 40°C
- Relative humidity: <85%
- Intensity of outside magnetic field: <400A/m
- Rotate speed: 0-9950r/min, step: 50 r/min

500W
Maximum Power
Test the Cap by 120ML

WT02J104T

FUEL INJECTOR CLEANER & TESTER

- Power supply: 220V±10%
- Frequency: 50Hz
- Relative humidity: <85%
- Environment temperature: 0°C ~ +40°C
- External magnetic field strength: <400A/m
- No open flames are allowed around

1300ml
Fuel Capacity
Test the Cap by 100ml

VG02Z0250

SMOKE LEAK DETECTOR

- Output Pressure: ≤14.5 psi
- Smoke Output: 6 L/min
- Main unit: 130*85*185mm
- Smoke leak detector
- Input Voltage DC 12V
- Current: 7A

6 L/min

WT04E0024

77KG WHEEL BALANCER TIRE BALANCERS

- Rim diameter: 10"-24"
- Max tire diameter: 1000mm
- Tire width: 1.5"-14"
- Max tire weight: 70kgs
- Rotation speed: 200r/min
- Balance precision: ± 1g
- Motor: 220V
- Machine weight: 77kgs



WT04E0025

TIRE CHANGER

- Max. wheel diameter: 980mm
- Machine weight: 156kg
- Wheel width: 3"-12"
- Rim clamping from outside: 10"-20"
- Rim clamping from inside: 12"-24"
- Operating pressure: 8-10bar
- Motor power: 0.75kW/1.1kW



E10103

6-12-24V CAR LIGHT TESTER

- Solid brass body with a test light.
- cord length 75CM



VG02H102B

28PC HOLLOW PUNCH SET

VG02H101B

18PC HOLLOW PUNCH SET

WFT01A036B

11" LONG REACH PLIERS NEEDLE NOSE

- Drop forged, heat treated steel.
- Non-slip double PVC dipped
- cushion grip handles.



WT04A407A

UNIVERSAL RADIATOR PRESSURE TESTER & VACUUM-TYPE COOLING SYSTEM KIT

- Application: MB, GM, Jeep, Peugeot, Subaru, Chrysler, Acura, Mitsubishi, Nissan, Mazda, Toyota, Infiniti, Geo, Suzuki, Isuzu, Honda, Acura, Lexus, Volvo, Saab, Citroen, Renault, Fiat, Alfa, Mini Cooper, VW, BMW, Ford, Opel, Porsche, Audi...etc



WT04B4150

UNIVERSAL MASTER DISC BRAKE TOOL REPAIR KIT

- Brake Bleeder/Wheel Cyl. (102), 106mm, and 22" x 9.5"
- Disc Brake Pad Spreader
- Disc Brake Rescuer
- Disc Brake Tacking Cutter
- Adjuster 1.5"-2" 1.5"-2.2" 2" 2.25" and 2.5"
- Short 2 Piece 1.4" 1.4" Adapter Long 2 Piece 1.4" 1.4" Adapter
- Disc Brake 1/4" x 1/4" 1/4" x 1/4" 1/4" x 1/4" 1/4" x 1/4"
- Hub Bolts 102 106 106 106 106 106 106 106
- 1/2" Brake 102 106 106 106 106 106 106 106
- The Adjuster Lubricator
- Adjustable 2pc & 3pc Brake Piston Rescuer/Spreader
- containing a wide range of vehicle applications.



WT01Z0547

13PCS TAP AND DIE SET

- For cleaning and after cutting wheel threaded holes and studs on the wheel hub.
- Complete with 10 mm (3/8") shots for actuation with Ratchet.
- M12 x 1.25 mm
- M12 x 1.50 mm
- M14 x 1.50 mm



HDA65

NEW HOLLOW PUNCH SET

- Alloy steel
- Soft grip handle
- 6mm, 8mm, 8mm, 10mm, 11mm, 13mm, 16mm, 19mm, 22mm, 25mm, 28mm, 32mm, 35mm



VG02G1345

DIGITAL TIRE INFLATOR

- Professionally calibrated digital pressure gauge for accurate readings between 0-150 PSI (0-10.34 Bar; 0-1034 Kpa; 0-10.5 kg/cm²) with resolution of 0.1 PSI within ±1% and pressure monitoring system.

0-150 PSI

VG01G1344

DIGITAL TIRE INFLATOR

- Measure tire pressures from 0-150psi, 20-1000 kpa
- Change readout between psi, kpa, bar and kg/cm²
- Back-lit LCD display
- Accurate within 1 psi

0-150 PSI**TELESCOPIC INSPECTION MIRROR-ROUND TELESCOPIC INSPECTION MIRROR-SQUARE TELESCOPING MAGNETIC PICK-UP TOOL-3.5LBS TELESCOPING MAGNETIC PICK-UP TOOL-5.5LBS TELESCOPING MAGNETIC PICK-UP TOOL-10LBS**

610578

610576

617035

617050

617100



GEAR PULLER & BEARING SPLITTER SET

12PC

Removes gears, pulleys, and steering wheels.

VG04001

- ▶ Drop forged, heat treated steel attachments.
- ▶ Heat treated precision machined steel bolts.
- ▶ Black oxide finished and chrome plated for durability.
- ▶ Removes gears, pulleys, and steering wheels.
- ▶ Separates ball bearings.

GEARPULLER & BEARING SPLITTER SET

8PC

VG04001A

- ▶ Drop forged, heat treated steel attachments.
- ▶ Heat treated precision machined steel bolts.
- ▶ Black finished and chrome plated for durability.

BEARING PULLER SET **VG04287**

14PC (WITH HOOK)

- ▶ Drop forged, heat treated steel attachments.
- ▶ Heat treated precision machined steel bolts.
- ▶ Black finished and chrome plated for durability.
- ▶ Removes gears, pulleys, and steering wheels.
- ▶ Separates ball bearings.

BEARING SEPARATOR SET

Removes gears, pulleys, and steering wheels.

2PC

VG04003

- ▶ Drop forged, heat treated steel attachments.
- ▶ Heat treated precision-machined steel bolts.
- ▶ Black oxide finished and chrome plated for durability.

BEARING SPLITTER

VG04316 **3/8" to 1-1/4"** Capacity
Forged Steel Construction

VG04317 **1-1/4" to 2-1/4"** Capacity
Forged Steel Construction

VG04318 **2-1/4" to 3-1/2"** Capacity
Forged Steel Construction

VG04319 **3" to 4-1/2"** Capacity
Forged Steel Construction



INNER BEARING PULLER

One slide hammer assemble & clamp.

5PC

VG04004

Open clamps by turning handle clockwise to snug against the bearing for pulling out evenly without damage the parts.



BLIND HOLE BEARING PULLER SET

9PC

VG04110

SIZE	DESCRIPTION
Shaft	Slide hammer shaft 290mm/L
Hammer	Hammer WG 100mm L-2.15kg (340g)
8mm	5/16" to 13/32" (6-10mm)
10mm	13/32" to 15/32" (10-12mm)
12mm	5/8" to 11/8" (12-14mm)
15mm	19/32" to 11/8" (15-17mm)
17mm	11/8" to 29/32" (17-20mm)
20mm	29/32" to 15/16" (20-24mm)
25mm	1" to 1-1/8" (25-29mm)
30mm	1-3/16" to 1-1/4" (30-32mm)



10 LBS DENT PULLER SET

- ▶ 10-Lb. Malleable steel slide hammer.
- ▶ Solid steel shaft with knurled handle for sure grip.
- ▶ Drop forged, steel hooks, pullers, and attachments.
- ▶ Fully hardened alloy steel attachments.



VG04005

13PC

▶ Ideal tool kit for professional auto-body repairs.

UNIVERSAL AXLES SLIDE HAMMER SET

17PC



- ▶ Combination puller with 5-lb. Malleable steel slide hammer.
- ▶ Drop forged steel pullers and attachments.
- ▶ Fully hardened shaft and accessories.
- ▶ Converts into a 2 or 3 jaw internal/external puller for reaching tight areas.

VG04006 **16PC**



SPECIAL STEERING WHEEL PULLER

VG04002



- ▶ Drop forged, heat treated steel
- ▶ Black oxide finished and chrome plated

HARMONIC BALANCE PULLER KIT



13PC

VG04007

- ▶ Drop forged, heat treated steel.
- ▶ Alloy steel center screw with floating, removable swivel applies even pressure, preventing damage.

VG04333

HARMONIC BALANCE PULLER KIT

46PC

VG04008



- ▶ Drop forged, heat treated steel.
- ▶ Alloy steel center screw with floating, removable swivel applies even pressure, preventing damage.



VG04344

HARMONIC BALANCER PULLER

- ▶ 11pc cap screws 3/8"-24x2" (3), 5/16"-18x2" (3)
- ▶ M8x1.25mmx80mm (3), 3/8"-16x4" (3)
- ▶ 1pc 5/8" main center bolt.
- ▶ 1pc 4 slot yoke.
- ▶ 1pc-pointed shaft protector.

- ▶ This device removes vibration dampers, balancers, Pulleys and gears with tapped holes.
- ▶ Force is evenly distributed upon application.
- ▶ Applies to most foreign and import vehicles.

BMC 10SETS/CTNS CTN Size: 41*31.5*16.7



STEERING WHEEL PULLER

- ▶ All heavy duty components.
- ▶ Fits vehicles with 4" hubs.
- ▶ Complete with SAE and metric threaded bolts.

BMC 10SETS/CTNS CTN Size: 41*31.5*16.7

VG04345

STEERING WHEEL REMOVER/ LOCK PLATE COMPRESSOR SET



VG04150

Removing steering wheels of most vehicles with or without telescoping tilt. Steering columns is easy with this new set. The steering wheel lock plate compressor is also included, to compress the steering wheel lock plate to remove or install the snap ring.

BMC 36SETS/CTNS CTN Size: 53*27.5*44

STEERING WHEEL PULLER

VG04324



- ▶ All heavy duty components.
- ▶ Fits vehicles with 4" hubs.
- ▶ Complete with SAE and metric threaded bolts.

STEERING WHEEL LOCKPLATE TOOLS

VG04325



Includes 2 puller yokes.

- ▶ Compatible with many domestic steering wheels including tilt and telescoping models.
- ▶ SAE and metric adaptors included.
- ▶ For easy removal and installation of lock ring.
- ▶ Heavy duty construction.
- ▶ Sizes: Small 1 7/8", Large 3"

STEERING WHEEL LOCK PLATE TOOL

VG04326



Compatible with many domestic and import steering wheels including tilt and telescoping models. Size: 3" yoke width.

STEERING WHEEL REMOVER SET

VG04327



- ▶ SAE and metric threaded bolts for vehicles with 4" hubs.
- ▶ Includes puller legs for late model applications.

STEERING WHEEL PLATE PULLER



- ▶ Removes steering wheel lock plate for most vehicles with tilt and telescoping columns.
- ▶ Designed for air bag equipped vehicles.
- ▶ Sizes: 9/16" x 18mm and M14 x 1.5mm adapters.

VG04328

VG04329

- ▶ Pulls pressed on 1 and 2 groove pulleys on alternators and power steering pumps.
- ▶ Also removes some alternator bearings.
- ▶ Adjustable jaw tension.
- ▶ Heavy duty construction.

PULLEY PULLER



H/D HYD. VALVE LIFTER REMOVER

VG04331



- ▶ Collet expands to tightly grasp hydraulic valve lifter allowing for easy removal.
- ▶ Specially designed slide hammer easily frees tight or stuck lifters.
- ▶ Knurled handle for secure grip.
- ▶ High quality steel construction.

TIMING GEAR PULLER



VG04332

- ▶ Removes timing gears and other gears with tapped holes.
- ▶ Drop forged yoke is plated to resist corrosion.
- ▶ Heat treated center screw.
- ▶ Includes two 5/16" x 4" bolts.

GEAR PULLER HYDRAULIC

VG04049



10Ton

6-WAY MULTI PURPOSE

- ▶ MULTI-PURPOSE
- ▶ 2/3 leg configuration
- ▶ Up to 10 Ton capacity



3 JAW GEAR PULLER

- ▶ Heat treated alloy steel.
- ▶ Drop forged for strength.
- ▶ Chrome plated finish.



VG04307 3" 3 JAW

VG04308 4" 3 JAW

VG04309 6" 3 JAW

VG04310 8" 3 JAW

2 JAW GEAR PULLER

VG04320

3-1/4" REACH, 4" SPREAD



VG04321

3-1/4" REACH, 4-3/4" SPREAD

- ▶ Heavy duty chrome vanadium steel construction.
- ▶ Heat treated jaws.
- ▶ Fine thread center bolt for smooth operation.
- ▶ Plated to resist corrosion.

2/3 JAW GEAR PULLER

VG04322

3-1/4" REACH, 7" SPREAD



VG04323

5-1/4" REACH, 7" SPREAD

- ▶ Heavy duty chrome vanadium steel construction.
- ▶ Heat treated jaws.
- ▶ Fine thread center bolt for smooth operation.
- ▶ Plated to resist corrosion.



2 JAW GEAR PULLER

VG04311 4" 2 JAW

VG04312 6" 2 JAW

GEAR PULLER 2 JAW



- ▶ Heat treated alloy steel.
- ▶ Drop forged for strength.
- ▶ Chrome plated finish.

VG04314 2 JAW 6"

VG04315 2 JAW 8"

3-1/2" 2 JAW GEAR PULLER

- ▶ Heat treated alloy steel.
- ▶ Drop forged for strength.
- ▶ Chrome plated finish.

VG04313

VALVE SPRING COMPRESSOR T-HANDLE OVER HEAD

VG04213



- ▶ Removes valve spring keepers and springs without removing the cylinder head.
- ▶ Adjusts to fit springs on most cars.
- ▶ Features sliding "T" handle for close clearances.

UNIVERSAL PULLER SET

VG04050



**3
SIZE**

- ▶ 2 leg
- ▶ Variable width
- ▶ Chrome molybdenum
- ▶ Legs: 100 - 200 And 250mm Long

**BALL JOINT SEPARATOR
(SCISSOR TYPE)**

- ▶ Black finished
- ▶ Jaw opening 19mm,



20~50MM



VG04063

PITMAN ARM PULLER

VG04334



- ▶ Drop forged steel.
- ▶ Opening size 1 5/16" (33mm).
- ▶ Pull travel 2 1/2" (63mm).
- ▶ 3/8" drive square port in center screw allows for use with 3/8" drive ratchet.
- ▶ Fits most cars and light trucks.



VG04064

BALL JOINT SEPARATOR

- ▶ Universal tool for separation of ball joints.
- ▶ Can be adjusted in two sizes for wider working areas.
- ▶ Opening: 20mm
- ▶ Adjustable Height: 48mm

20~50MM



(SCISSOR TYPE)

**TIE ROD END/
PITMAN ARM PULLER**

VG04335



- ▶ Removes tie rod ends and pitman arm assemblies from many cars and light trucks.
- ▶ Opening size 1 1/8" (29mm).
- ▶ Pull travel 2 1/8" (54mm).
- ▶ 3/8" drive square port in center screw allows for use with 3/8" drive ratchet.
- ▶ Heat treated center screw.
- ▶ Drop forged alloy steel yoke.

TIE ROD PULLER

- ▶ Heavy duty steel construction and heat treated jaws.
- ▶ For pulling worn tie rod ends on most FWD and RWD autos.

VG04336



- ▶ Designed to remove tie rods with minimal damage to steering knuckle.
- ▶ Removes assortment of gears, pulleys and bearings.

PITMAN ARM PULLER, LARGE

- ▶ Drop forged steel.
- ▶ Opening size 1 5/16" (33mm).
- ▶ Pull travel 2 1/2" (63mm).
- ▶ 3/8" drive square port in center screw allows for use with 3/8" drive ratchet.
- ▶ Fits most cars and light trucks.

VG04337



UNIVERSAL PULLER SET



VG04341

- ▶ The puller legs are made in different sizes for narrow spaces.
- ▶ With pulling legs for narrow spaces in different lengths.
- ▶ Particularly well suited to be hung up on workshop walls.
- ▶ All required clamping depths available at any time

WIPER ARM REMOVAL TOOL

VG04208

- ▶ Ideal for the quick and easy removal of taper mounted wiper arms
- ▶ Designed to prevent damage
- ▶ Compact design for hard to reach places



- ▶ Center tip on forcing screw swivels to help remove and prevent damage to the tie rod stud.
- ▶ For use on imports and front wheel drive vehicles including SUV's with rack and pinion steering

TIE ROD PULLER

VG04338

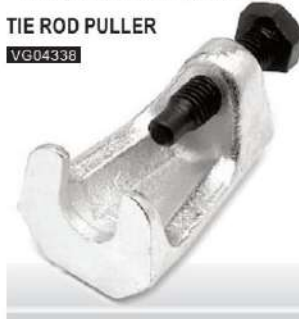

**19MM-22MM
BALL JOINT SEPARATORS**

VG04698



- ▶ For removal of ball pivots on tie-rods and stabilizers.
- ▶ Zinc plated



5 PC FRONT-END SERVICE SET

- ▶ For removal of most types of pitman arms, tie rods and ball joints found on automotive and light truck applications.
- ▶ Replacement parts availability.

VG04339

VG04340

NUT SPLITTER

VG04284

- Applicable:
- ▶ 9-12mm Nut Splitter
- ▶ 12-16mm Nut Splitter
- ▶ 16-22mm Nut Splitter
- ▶ 22-36mm Nut Splitter



STUD EXTRACTOR

VG04402



- ▶ Removes rusted, stripped and stubborn nuts.
- ▶ Self centering wobble tip.
- ▶ Offset design for easier operation.
- ▶ Splits nuts 7/16" to 3/4".
- ▶ Drop forged steel construction.
- ▶ Plated to resist corrosion.
- ▶ Heat treated chisel.

1/4" TO 3/4" STUD EXTRACTOR



VG04401

- ▶ For removing broken or seized studs, bolts, etc from 1/4" to 3/4" diameter.
- ▶ Knurled roller uses cam action to grasp stud firmly while minimizing damage.
- ▶ Use 1/2" drive ratchet.
- ▶ Sizes: 1/4 to 3/4"

5PC TAPERED EXTRACTOR SET

VG04696



- ▶ Removes broken studs, screws, bolts, pipes and pipe fittings.
- ▶ Chrome vanadium steel.
- ▶ Features flutes for more positive grip.
- ▶ Includes handy organizer.

7PC DOUBLE FLARING TOOL SET
VG04408



- ▶ Special design for double or single flare in copper, aluminum, soft steel brake line and brass tubing up to 45 degrees. Includes 3/16", 1/4", 5/16", 3/8", and 1/2"(4.8mm through 12.7mm).
- ▶ Chrome swivel is made of alloy steel to reduce friction.
- ▶ Forged yoke is made of heat treated steel.

TIE ROD / BALL JOINT / PITMAN ARM TOOL KIT
VG04028



- ▶ Drop forged
- ▶ heat steel forks.
- ▶ Contents: 2 handles, 3 different sizes of forks.

5PC

BALL JOINT ADAPTORS KIT MASTER SET

- ▶ Installation cups
- ▶ Removal cups
- ▶ Receiving tubes

Used in conjunction with a C-Frame Press (not included)



VG04010

This tool kit is designed to provide adaptors for all cars, vans and light trucks that have press-fit type ball joints

4 WHEEL DRIVE ADAPTORS BALL JOINT SERVICE KIT

VG04009

- ▶ C-frame and forcing screw
- ▶ Installation adaptor
- ▶ Removal adaptor
- ▶ Installation cups
- ▶ Removal cups
- ▶ Receiving tubes



Brake anchor pin removal and installation

This tool kit is designed for use on all cars and Light trucks that have press-fit type ball joints. Without the Need to remove the control arm from the vehicle.

4 WHEEL DRIVE ADAPTORS BALL JOINT SERVICE KIT

21PC MASTER

VG04011

For servicing universal joints on most cars, vans and light trucks
Brake anchor pin removal and installation



WHEEL BEARING REMOVAL TOOL

FOR THE REMOVAL AND INSTALLATION OF WHEEL BEARINGS ON FRONT-WHEEL DRIVE VEHICLES

This set reduces the chance of damage to hub and bearing. Also suitable for removing and installing large industrial bearings.



VG04037

Drive shaft: 32 & 38mm
Drift sizes: 50, 55, 60, 64, 67, 70, 72, 74, 75, 78, 82, 84, and 88mm

FRONT WHEEL DRIVE BEARING SERVICE KIT

MASTER 17PC

VG04039

SUITABLE FOR MOST FRONT WHEEL DRIVE CARS AND VANS
Comprehensive set for the removal and installation of front hub bearings without the need to dismantle the steering assembly.
Hub screws: M12 x 1.5 and M14 x 1.5mm
Drift sizes: 55, 59, 62, 65, 66, 71, 5, 73, 78, 84, 86, 91mm



CRANKSHAFT & CAMSHAFT SEAL REMOVER AND INSTALLER KIT

Material: steel & Alum.
Quick & easy work for both removal & installation work. Ideal for both crankshaft and camshaft seal.
Quick & easy work for both removal & installation work. Master kit includes wide size seal installers.
Provided with 2 seal removers with different length and angle fits for wide applications.
Angled blade seal remover is ideal for removing seals in limited space.

VG04783



CRANK SEAL REMOVER/INSTALLER KIT

VG04784



Material: steel & Alum.

- ▶ Allows the crank seal to be replaced without dismantling the crank case saving your time and costs.
- ▶ Do not worry about scraping the crank surface.
- ▶ Universal use covering a wide range of cars with oilseals between 27 mm and 58 mm in diameter.
- ▶ Use the existing bolt in the vehicle for installation.
- ▶ Screw-type adapter to fit the centering.
- ▶ The blue seal adapters are made of aluminum to prevent the damage of crank.
- ▶ Note: Do not attempt to use this tool by force. Some cam seals have screws to prevent remove.

7 PC BEARING RACE & SEAL DR SET

VG04782



Quickly and easily installs wheel bearing races and seals without destruction to race or axle housing. Set includes six discs to fit common bearing sizes. Sizes: 1.565, 1.75, 1.965, 2.325, 2.47 & 2.555"

CLUTCH ALIGNMENT TOOL - MM SET



VG04763

Plated aligning cone with graduated 1" and 1 1/8" diameters for "automatic" fit to most clutch plates. Tapered cone for all others.
Shaft & bushings to fit 10 metric pilot bearing sizes. Plated aligning cone with graduated diameters for "automatic" fit to most clutch plates. Tapered cone for all others.
Sizes SAE: .590, .612, .624, .668, .749, .786, .808 & .904"

BEARING RACE AND SEAL DRIVER SET

11PC



VG04012

- ▶ Collars fit most standard wheel bearing sizes.
- ▶ The three largest sizes fit most late-model 4 wheel drive vehicles.
- ▶ Handle: 3/4" long ▶ Collar: 1.565", 1.750", 1.965", 2.325", 2.555", 2.470", 2.830", 2.995", 3.180" long.

METRIC BUSHING DRIVER SET

▶ 3 driver handle

17PC

Stock no.	I.D.	O.D.
1	10	14
2	12	14
3	14	16
4	15	17
5	16	18
6	18	20
7	20	22
8	22	24
9	25	27
10	26	30
11	30	34
12	32	36
13	35	40
14	38	42

VG04013

UNIVERSAL CLUTCH ALIGNING KIT



VG04227

17PC

- ▶ For fast accurate alignment of flywheel pilot hole and clutch drive plate when assembling to car.
- ▶ Applications: Audi, Citroen, Fiat, Ford, Honda, Mazda, Mitsubishi, Nissan, Opel, Peugeot, Renault, Rover, Saab, Toyota, Vauxhall, VW, Volvo

DRIVE 1/2"



VG04025

MINI TYPE MANUAL TORQUE TIRE WRENCH WITH 3 SOCKETS: 17, 19, 21mm

- ▶ Mirror polished and chrome plated.
- ▶ Maximum safe output torque: 300N.m
- ▶ Only by Hands, drivers can change tires very easily & quickly at any place.

DRIVE 1"



VG04024

LONGER TYPE MANUAL TORQUE TIRE WRENCH WITH 38MM CRV SOCKETS

- ▶ The wrench can be used to disassemble various kinds of truck tires
- ▶ Transmission ratio: 1:68
- ▶ Maximum safe output torque: 4800N.m

DRIVE 3/4"



VG04097

LONGER TYPE MANUAL TORQUE TIRE WRENCH WITH 30-32-33MM CRV SOCKETS

- ▶ The wrench can be used to disassemble various kinds of truck tires
- ▶ Transmission ratio: 1:68
- ▶ Maximum safe output torque: 4800N.m

GM WATER PUMP REMVR & INST SKT



VG04350

- Specially designed for use on 1993 to current Northstar 4.6 Liter, 1997 to current Aurora 4.0 Liter.
- 1/2" drive size.
- Chrome molybdenum.



VG04351

ACURA CRANK PULLEY TOOL

- For removal & installation of crankshaft pulley bolt.
- Fits most Honda and Acura engines.
- 60mm diameter.
- Not for impact use.
- Hex shape fits hole in center of crankshaft pulley.
- Prevents engine from turning when held with breaker bar.

FWD AXLE NUT SKT CHR-MOLY



- For removal or installation of axle nuts on front wheel drive vehicles.
- Heavy duty chrome moly alloy steel.
- Fits many GM applications.

VG04352

29mm fits late model GM and Ford Escort and Fiesta 1985 to current.

HANG TAB 24PCS/CTNS CTN Size: 20.6"18"29.5

VG04353

30mm GM "X", "J" and "A" body style cars.

HANG TAB 24PCS/CTNS CTN Size: 20.6"18"29.5

VG04354

31mm Honda.

HANG TAB 24PCS/CTNS CTN Size: 20.6"18"29.5

VG04355

32mm late model Honda and Chrysler front wheel drive vehicles

HANG TAB 24PCS/CTNS CTN Size: 20.6"18"29.5

VG04356

33mm fits many GM and Chrysler applications.

HANG TAB 24PCS/CTNS CTN Size: 20.6"18"29.5

VG04357

34mm 1991 through current Buick Electra, Cadillac Fleetwood and DeVille, Oldsmobile 98, 1992 through current Buick Le Sabre and Riviera, Cadillac Eldorado and Seville, Chevy Lumina, Oldsmobile Delta 88, Silhouette and Toronado, Pontiac Bonneville and Transport, 1993 through current Cadillac Allante.

HANG TAB 24PCS/CTNS CTN Size: 20.6"18"29.5

VG04358

35mm fits many late model GM vehicles.

HANG TAB 24PCS/CTNS CTN Size: 20.6"18"29.5

VG04359

36mm GM "E" body style cars.

HANG TAB 24PCS/CTNS CTN Size: 20.6"18"29.5

VG04360

38mm fits GM trucks.

30MM AXLE NUT SOCKET

- Heavy duty chrome moly alloy steel.
- Size: 30mm

VG04361

12PT



34MM AXLE NUT SOCKET

- Heavy duty chrome moly alloy steel.
- Size: 34mm

VG04362

36MM AXLE NUT SOCKET

- Heavy duty chrome moly alloy steel.
- Size: 36mm

VG04363

AXLE NUT SOCKET SET

- For removal or installation of axle nuts.
- 1/2" drive 6 point design.
- Heavy duty chrome moly alloy steel construction.
- Sizes: 29, 30, 31, 32, 33, 34, 35, 36 and 38mm.

VG04364

9PC



4 X 4 SPINDLE NUT WR SET

VG04371

6PC



- For many 2 wheel and 4 wheel drive light truck applications.
- Includes 4x4 spindle removing socket.
- Includes Toyota locknut wrench.
- Replacement part availability.
- Replacement part availability.

1/2 TON 4WD LOCKNUT TOOL CHR-V



VG04365

- For quick and easy removal and installation of 4 slot front axle lock nuts on many 1/2 ton trucks.
- For use with 1/2" drive tool.
- For 1993 to current Ford Rangers, Bronco I's, and Explorers with manual hubs.
- 1995 to current Ford F-150, F-250 and F-350 trucks with manual hubs.
- 1995 to current Broncos with manual hubs.
- 1993 through 1985 Ford F-150, F-250 and F-350 trucks and Broncos.
- 1990 through 1990 GM G10, K10, G1500 and K1500 trucks and full size Blazer and Jimmy.
- 1993 through 1989 Dodge 1/2 ton trucks with manual hubs.
- Reinforced outer lug sleeve for heavy duty applications.
- Heavy duty chrome moly alloy steel construction.

FORD/GM 4WD LOCKNUT TOOL CHR-V



VG04366

- For quick and easy removal and installation of 4 slot front axle lock nuts.
- For use with 1/2" drive tool.
- For 1978 through 1994 Ford 4WD heavy duty F-250 and F-350 trucks, 1973 through 1981 GM 4WD K20, K2500, K30 and K3500 trucks.
- Heavy duty chrome moly alloy steel construction.

LOCKNUT TOOL 1/2 TON 4 LUG 4WD



VG04367

- For quick and easy removal and installation of 4 slot front axle lock nuts on many 1/2 ton trucks.
- For use with 1/2" drive tool.
- For 1980 through 1996 Ford F-150, F-250, F-350 and full size Bronco with Dana 44 front axle.
- 1984 through 1992 Ford Ranger and Bronco II with manual hubs.
- 1990 through 1993 Dodge trucks with automatic hubs.
- Reinforced outer lug sleeve for heavy duty applications.
- Heavy duty chrome moly alloy steel construction.

4 LUG SPINDLE NUT WRENCH



VG04369

- For use on 1985 to current F-250 and F-350 rear axles with high shear axle nuts and Dana 80 rear axles.
- Center tube aligns wrench to nut.
- Heavy duty chrome moly alloy steel construction.

TOYOTA LOCKNUT WRENCH

VG04368



- For 1995 to current Tacoma and 1996 to current T100 and 4 Runners.
- Four pin design for quick and easy removal.
- Removes locknuts from vehicles with new design front wheel bearings.
- For use with 1/2" drive tool.
- Heavy duty chrome moly alloy steel construction.

4WD SPINDLE NUT WRENCH (GM,FORD)

- For use on 1982 to 1990 3/4 ton and 1 ton GM heavy duty trucks.
- 1985 to current 1/2 ton Ford F Series and full size Bronco with Dana 28 front axle.
- 1985 and 1/2 to current Ford F-250 heavy duty truck.
- 1985 and 1/2 to current Ford F-350 4x4, Dana 50 IFS and Model 60 mono beam outer adjusting nut.
- Heavy duty chrome moly alloy steel construction.

VG04370



FRONT HUB REMOVER / INSTALLER

VG04372



- For use on most front wheel drive vehicles.
- Includes hub installer for some Ford applications.
- Bilingual instructions.
- Replacement part availability.

1/2"DR. WHEEL BEARING



7PC

VG04373

- Contains one each 2 3/8", 2 1/2" and 55mm locknuts.
- One each 2 1/2", 2 3/4", 2 9/16" and 2 3/8" rounded locknuts.
- Replacement part availability.

1/2 DR LOCK NUT SKT 2-3/8" HEX

VG04374



- 2 3/8" 6 point hex socket for use on 1993 to current Ford Explorer, Ranger, and Bronco II with automatic hubs.

1/2" DR LOCK NUT SOCKET 2-3/8"



VG04375

- ▶ 2-3/8" 6 point rounded socket for use on 1990 to current Ford Explorer, Ranger and Bronco II with automatic hubs.

1/2" DR LOCK NUT SKT 2-1/2" HEX

VG04376



- ▶ 2-1/2" 6 point hex socket for use on many front and rear axle light duty truck applications.

1/2" DR LOCK NUT SKT 2-1/2"

VG04377



- ▶ 2-1/2" 6 point rounded socket for use on 1995 to current Ford F-150 and full size Bronco with automatic hubs.

1/2" DR LOCK NUT SKT 2-9/16"

VG04378



- ▶ 2-9/16" 6 point rounded socket for use on 1990 through 1993 Dodge trucks with Dana 60 manual hubs.

1/2" DR LOCK NUT SKT 2-3/4"

VG04379



- ▶ 2-3/4" 6 point rounded socket for use on 1995 to current Ford F-250 and F-350 trucks with automatic hubs.

1/2" DR LOCK NUT SKT 55MM HEX

VG04380



- ▶ 55mm 6 point hex socket for use on Toyota, RN, LN, FJ models with front adjusting nuts.

1-3/16" OIL PRESSURE SWITCH SKT

VG04381



- ▶ Fits 1-3/16" size units on 1987 to current GM including Chevy, Buick, Cadillac, Oldsmobile and Pontiac with 2.0, 2.5, 2.8 and 3.0 Liter engines.
- ▶ Use with 1/2" drive ratchet or 7/8" wrench.
- ▶ Heat treated alloy steel construction.
- ▶ Size: 1-3/16"

MAGNETIC SPARK PLUG SOCKET

2PC

VG04393



- ▶ The permanent magnet in this socket will not wear out or be damaged by exposure to oil or humidity
- ▶ Durable construction for a strong performance
- ▶ 5/8" 13/16" in size and has a 3/8" drive

3/8" DR. 5/8" EXT SPARK PLUG SKT

VG04404



- ▶ Extended socket length reaches confined areas.
- ▶ Knurled design offers better grip when hand turning.
- ▶ Rubber insert grips plug.
- ▶ 5" overall length.
- ▶ Heat treated alloy steel construction.
- ▶ Size: 5/8"

1/2-INCH DRIVE EXTENSION BAR SET

VG04394

3PC



- ▶ Drop forged chrome carbon steel
- ▶ Durable chrome plated finish resists corrosion
- ▶ Spring loaded ball bearing locks on to sockets
- ▶ 3-piece 1/2-Inch driver extensions: 3-Inch, 6-Inch, 9-Inch

5/8" MAGNETIC T-HANDLE SPARK PLUG SOCKET

VG04391



- ▶ The permanent magnet in this socket will not wear out or be damaged by exposure to oil or humidity
- ▶ Durable construction for a strong performance
- ▶ 5/8" in size and has a 3/8" drive

MAGNETIC T-HANDLE SPARK PLUG SOCKET

VG04392

13/16"



- ▶ The permanent magnet in this socket will not wear out or be damaged by exposure to oil or humidity
- ▶ Durable construction for a strong performance
- ▶ 13/16" in size and has a 3/8" drive

1/2" NEIKO PRO-GRADE LOCKING EXTENSION BAR SET

VG04398



- ▶ Forged Chrome Vanadium steel shaft, heat treated and chrome plated with mirror finish.
- ▶ Sprung ball locking mechanism retains socket on extension until released.
- ▶ Deep knurling on lock ring allows extra grip for oily fingers.
- ▶ Length: 3", 6", 10".

LOCK EXTENSION BAR SET

**1/4" DR. X8"
3/8" DR. X8"
1/2" DR. X15"**

VG04397



- ▶ Forged Chrome Vanadium steel shaft, heat treated and chrome plated with mirror finish.
- ▶ Sprung ball locking mechanism retains socket on extension until released.
- ▶ Deep knurling on lock ring allows extra grip for oily fingers.

LOCK EXTENSION BAR SET

- ▶ Forged Chrome Vanadium steel shaft, heat treated and chrome plated with mirror finish.
- ▶ Sprung ball locking mechanism retains socket on extension until released.
- ▶ Deep knurling on lock ring allows extra grip for oily fingers.

**1/4" DR. X4"
3/8" DR. X5"
1/2" DR. X5"**

VG04396



LOCK EXTENSION BAR SET

- ▶ Forged Chrome Vanadium steel shaft, heat treated and chrome plated with mirror finish.
- ▶ Sprung ball locking mechanism retains socket on extension until released.
- ▶ Deep knurling on lock ring allows extra grip for oily fingers.

**1/4" DR. X3"
3/8" DR. X3"
1/2" DR. X3"**

VG04395



4 PC SWIVEL SPARK PLUG SOCKET SET

VG04399



- ▶ Contents 9/16, 5/8, 3/4, 13/16" swivel spark plug sockets

FLEXI-HEAD SOCKET WRENCH SET



VG04409

- ▶ 6pc Flexi-Head Socket Wrench Set with Dual heads
- ▶ Sizes - 8, 9, 10, 11, 12, 13, 14, 15, 16, 17, 18, 19mm

VG04409-3

FLEXI-HEAD SOCKET WRENCH 12,13mm

VG04409-6

FLEXI-HEAD SOCKET WRENCH 18,19mm

VG04409-1 8,9mm

VG04409-2 10,11mm

VG04409-4 14,15mm

VG04409-5 16,17mm

8PC CONVERSION JOINT GROUP SET

VG04759



- ▶ 1/4X3/8, 3/8/1/4, 3/8X1/2, 1/2X3/8, 1/2X3/4, 3/4X1/2, 3/4X1, 1X3/4

4 PC IGNITION TUNE-UP KIT



4PC VG04403

- ▶ For spark plug replacement in most foreign and domestic autos and light trucks.
- ▶ Heat treated alloy steel.
- ▶ 3/8" dr ratchet, 6" extension, 5/8" and 13/16" spark plug sockets.
- ▶ Sizes: 5/8 and 13/16"

COMPACT OXYGEN SENSOR SOCKET SIZE: 7/8"

VG04382



- ▶ Removes and installs sensors on computerized engine control vehicles.
- ▶ 3/8" dr. 7/8" 6 pt. socket with cutaway portion for wire clearance.
- ▶ Offset design for confined areas.
- ▶ Heavy duty alloy steel construction.

OXY. SEN. WRENCH

1/2 INCH

VG04077



- ▶ Designed for oxygen sensors in exhaust manifolds of 1981 and later model cars and trucks 1/2" drive, 22mm(7/8") 12pt socket
- ▶ Black oxide finish resists rust and corrosion

OXYGEN SENSOR SOCKETS 22mm * 7/8" * 3/8" & 1/2"Dr

VG04385



- ▶ Removes and installs sensors on computerized engine control vehicles.

Bliaster PACK 48PCS/CTNS CTN Size: 29.5"29"25

VG04384



- ▶ 3/8" drive 7/8" 6 point socket with cutaway portion for wire clearance.
- ▶ Offset design for confined areas.
- ▶ Removes and installs sensors on computerized engine control vehicles.
- ▶ Heavy duty alloy steel construction.

HANG TAB 72PCS/CTNS CTN Size: 26.2"19.3"44.7

OXYGEN SENSOR SOCKET CHR-V



- ▶ Removes sensors on computerized engines.
- ▶ Cutaway slot for sensor wire clearance.
- ▶ Alloy steel construction. Heavy duty alloy steel construction

VG04383

HANG TAB 72PCS/CTNS CTN Size: 22.4"28"62

CUMMINS FUEL FILTER SOCKET



VG04544

- ▶ Fuel filter socket for Dodge Cummins 5.9L fuel filter.
- ▶ Use this low profile 29mm socket on the raised hex on the fuel filter housing.
- ▶ Note: Not for impact use.
- ▶ Size: 29mm

SOCKETS STORE INSIDE BAG

VG04649



- ▶ Standard Sizes **3/8"DR.**
- ▶ 8 9 10 11 13 14 17 19mm ratchet;
- ▶ Quick released push ▶ Quick Action reverse button

SOCKETS STORE INSIDE HANDLE

VG04652



- ▶ Standard Sizes **1/4"DR.**
- ▶ 6 7 8 9 10 11 13mm ratchet

D/Bliaster PACK 24SETS/CTNS CTN Size: 43"40"39

SOCKETS STORE INSIDE BAG

VG04650



- ▶ Standard Sizes **1/4"DR.**
- ▶ 6 7 8 9 10 11 13mm ratchet;
- ▶ Quick released push ▶ Quick Action reverse button

SOCKETS STORE INSIDE HANDLE

VG04653



- ▶ Standard Sizes **1/2"DR.**
- ▶ 17 19 21 22 24mm ratchet; crv

D/Bliaster PACK 24SETS/CTNS CTN Size: 43"40"39

SOCKETS STORE INSIDE BAG

VG04651



- ▶ Standard Sizes **1/2"DR.**
- ▶ 17 19 21 22 24mm ratchet; CRV.
- ▶ Quick released push ▶ Quick Action reverse button

SOCKETS STORE INSIDE HANDLE

VG04654



- ▶ Standard Sizes **3/8"DR.**
- ▶ 8 10 12 13 14 17 19mm ratchet

D/Bliaster PACK 24SETS/CTNS CTN Size: 43"40"39

OXYGEN SENSOR WRENCH SET

3PC VG04151
SOCKETS 3/8" DRIVE

- ▶ Installs and removes oxygen sensors and vacuum switches on most vehicles.
- ▶ CR-Mo steel

7PC VG04042
SOCKETS 1/2" DRIVE

- ▶ For removal or replacement of heated and non-heated oxygen sensors
- ▶ Cut-away sections allow sockets to fit over
- ▶ Wiring harnesses
- ▶ Cut-away sockets 22mm(7/8") 27mm and 29mm
- ▶ Wrenches (cut-away) 22mm deep and shallow
- ▶ Standard deep 27mm

ENGINE TOOLS INNER TIE ROD TOOL VG04758



- Works on the inner tie rods where a spanner is barely possible.
- Seven crows feet sizes 1-3/16", 1-1/4", 1-5/16", 1-7/16", 14mm, 17mm and 33.6mm.
- The long socket then slips over the tie rod end and connects to the crows foot.
- 1/2 inch drive.
- Makes changing faulty inner tie rods simple and pain free.
- Suits all rack and pinion Mitsubishi's.

TRACK ROD END REMOVER & INSTALLER



VG04781

- Head OD : 89mm; Hollow body: 400mmL, hex part on the end of tool: work w/ht 27mm hex wrench or 1/2" DR. Wrench.
- Head application 35-45MM.

FOR SANTANA JIEDA & AUDI SPECIAL TOOL

VG04113

26PC



1/2DR 17" FLEX HANDLE

VG04857



- Chrome vanadium alloy steel construction for strength and durability.
- Polished nickel chrome plated finish resists corrosion.

1/2" EXTENDABLE RATCH

VG04859



- 6 locking positions
- 72-tooth gear action
- TPR handle for comfort and improved grip
- Extends from 12" to over 17" long
- Heavy duty chrome vanadium steel construction for strength and durability
- Overall dimensions: 12" L x 1-9/16" W x 1-9/16" H
- Extended: 17-9/16" L

1/2" DR HIGH TORQUE FLEX HANDLE

VG04860



- Ratchet head swivels 180 degrees.
- Heavy duty chrome vanadium steel construction.
- 3 way ratcheting action: right hand, left hand or locked.
- Master 12 inner 6

1/2" DR CLICK TORQUE WRENCH

- Professional style.
- Chrome plated alloy steel.
- Compact size for tight spots.
- Ratchet style with engraved scale.
- Nickel chrome plated alloy steel.
- Size: 1/2" Dr., 10 to 150 in. lbs

VG04661



3/8" DR CLICK TORQUE WRENCH

VG04662



- Professional style.
- Chrome plated alloy steel.
- Compact size for tight spots.
- Ratchet style with engraved scale.
- Nickel chrome plated alloy steel.
- Size: 3/8", 120 to 960 in. lbs.

SAE NUT DRIVER SET

VG04503



- Pro style polypropylene handles.
- Chrome plated drop forged steel shafts.
- Hollow shanks.
- Sizes: 3/16, 1/4, 5/16, 11/32, 3/8, 7/16 and 1/2"

TAMPER PROOF STAR SKT SET

9PC

VG04456



- Chrome vanadium steel sockets with professional sand finish.
- Heat treated alloy steel bits.
- Bonus storage rail included.
- 1/4" Dr. Sizes: T10, T15, T20, T25, T27 and T30
- 3/8" Dr. Sizes: T40, T45 and T50

5 LOBE SOCKET SET

10PC

VG04457



- 3/8" drive.
- Chrome vanadium steel construction.
- Bonus storage rail included.
- Sizes: 10, 15, 20, 25, 27, 30, 40, 45, 50 and 55

14 STAR DRIVER BITS

VG04458



- One 3/8" female to 1/4" male adaptor plus 2 bonus storage rails.
- Hardened alloy steel bits.
- Professional sand finish.
- 1/4" Drive Sizes: T10, T15, T20, T25, T27 and T30
- 3/8" Drive Sizes: T40, T45, T47, T50, T55 and T60

POWER DRILL SOCKET ADAPTER

VG04460

3PC



- 2" hex shank
- 1/4, 3/8 and 1/2" dr
- Chrome vanadium steel construction
- Ball bearing ensures sockets are securely seated
- Transforms your power drill into a power nut driver

TAMPER RESIS STAR BIT SET

8PC

VG04470



- 1/4" hex to 1/4" square drive adaptor.
- Heat treated alloy steel.
- Includes storage boot.
- Sizes: T10, T15, T20, T25, T27, T30 and T40

STAR DRIVER BIT SET

VG04471

15PC



- 14 star driver bits and one 3/8" drive adaptor.
- Chrome vanadium steel construction.
- Heat treated for strength.
- Packaged in storage tray.
- Short Shank Sizes: T10, T15, T20, T25, T30, T40, T45
- Long Shank Sizes: T20, T25, T30, T40, T45, T50, T55

12 POINT METRIC BIT SET

VG04465



- Heat treated alloy steel.
- 1/2" hex drive shaft.
- Sizes: 6, 8, 10 & 12 mm

4PC

Blister PACK 48PCS/CTNS CTN Size: 23.1"21.3"22.1"

L-SHAPE STAR DRIVER SET

6PC

VG04495



- Chrome vanadium steel construction.
- Sizes: T40, T45, T47, T50, T55 and T60

Blister PACK 24PCS/CTNS CTN Size: 28.2"25.9"37.8"

SAE/MET HEX KEY SET

VG04497

25PC



- Alloy steel construction.
- Plastic holder folds open or separates for versatile storage.
- SAE sizes: 1/16, 5/64, 3/32, 7/64, 1/8, 9/64, 5/32, 3/16, 7/32, 1/4, 5/16 and 3/8".
- Sizes: 1.27, 1.5, 2, 2.5, 3, 4, 4.5, 5, 5.5, 6, 7, 8 and 10mm.

Blister PACK 24PCS/CTNS CTN Size: 32.3"28"39.6"

SAE/MET BALL END HEX VG04496

22PC



- ▶ Alloy steel construction.
- ▶ Ball end wrenches are perfect for quick and convenient access to screw heads at angles up to 25 degrees.
- ▶ Includes plastic holder for storage.
- ▶ SAE sizes: 0.05, 1/16, 5/64, 3/32, 7/64, 1/8, 9/64, 5/32, 3/16, 7/32, 1/4, 5/16 and 3/8"
- ▶ Sizes: 1.5, 2, 2.5, 3, 4, 5, 6, 8 and 10mm.

PROFESSIONAL GROOVE JOINT PLIERS

10"



VG04667

- ▶ Precision machined tongue, grooves and tapered jaws
- ▶ Hardened and tempered
- ▶ Non-slip comfort grip
- ▶ Exceeds US standards and ANSI specifications
- ▶ Regulate the function

SELF-LOCKING POWER LOCKING PLIERS

7"



VG04668

- ▶ Heat-treated carbon steel construction with heavy duty jaws and handle will take years of hard work
- ▶ Welded screw seam for long life
- ▶ Satin chrome finish
- ▶ Wire cutter
- ▶ Automatic adjustment function

SELF-LOCKING POWER LOCKING PLIERS

10"



VG04669

- ▶ Heat-treated carbon steel construction with heavy duty jaws and handle will take years of hard work
- ▶ Welded screw seam for long life
- ▶ Satin chrome finish
- ▶ Wire cutter
- ▶ Automatic adjustment function

SELF-LOCKING POWER LOCKING PLIERS

11"



VG04670

- ▶ Heat-treated carbon steel construction with heavy duty jaws and handle will take years of hard work
- ▶ Welded screw seam for long life
- ▶ Satin chrome finish
- ▶ Wire cutter
- ▶ Automatic adjustment function

SELF-LOCKING POWER LOCKING PLIERS

8"



VG04681

- ▶ Heat-treated carbon steel construction with heavy duty jaws and handle will take years of hard work
- ▶ Welded screw seam for long life
- ▶ Satin chrome finish
- ▶ Wire cutter
- ▶ Automatic adjustment function

SELF-LOCKING POWER LOCKING PLIERS

15"



VG04671

- ▶ Heat-treated carbon steel construction with heavy duty jaws and handle will take years of hard work
- ▶ Welded screw seam for long life
- ▶ Satin chrome finish
- ▶ Wire cutter
- ▶ Automatic adjustment function

SELF-LOCKING POWER LOCKING PLIERS

20"



VG04672

- ▶ Heat-treated carbon steel construction with heavy duty jaws and handle will take years of hard work
- ▶ Welded screw seam for long life
- ▶ Satin chrome finish
- ▶ Wire cutter
- ▶ Automatic adjustment function

MULTI-FUNCTION PLIERS

14-1



VG04676

- ▶ 420 HC clip-point knife blade
- ▶ Needlenose pliers, regular pliers, wire cutters
- ▶ Spring-action scissors, wood/metal file, bottle opener
- ▶ Flat/Phillips medium regular screwdrivers
- ▶ Stainless steel with hard-anodized aluminum handle scales and outside-accessible tools, key ring attachment. Head retractable

MULTI-FUNCTION PLIERS

10-1



VG04677

- ▶ 420 HC clip-point knife blade
- ▶ Needlenose pliers, regular pliers, wire cutters
- ▶ Spring-action scissors, wood/metal file, bottle opener
- ▶ Flat/Phillips medium regular screwdrivers
- ▶ Stainless steel with hard-anodized aluminum handle scales and outside-accessible tools, key ring attachment. Head retractable
- ▶ Handle up or down

MULTI-FUNCTION PLIERS

12-1



VG04678

- ▶ 420 HC clip-point knife blade
- ▶ Needlenose pliers, regular pliers, wire cutters
- ▶ Spring-action scissors, wood/metal file, bottle opener
- ▶ Flat/Phillips medium regular screwdrivers
- ▶ Stainless steel with hard-anodized aluminum handle scales and outside-accessible tools, key ring attachment. Head retractable

MULTI-FUNCTION PLIERS

18-1



VG04679

- ▶ 420 HC clip-point knife blade
- ▶ Needlenose pliers, regular pliers, wire cutters
- ▶ Spring-action scissors, wood/metal file, bottle opener
- ▶ Flat/Phillips medium regular screwdrivers
- ▶ Stainless steel with hard-anodized aluminum handle scales and outside-accessible tools, key ring attachment. Head retractable

3 PC MM FLARE NUT WRENCH SET



FLARE NUT WRENCH

VG04635-1 MM Sizes: 6 x 8 mm

VG04635-2 MM Sizes: 8 x 10 mm

VG04635-3 MM Sizes: 9 x 11 mm

VG04636-1 MM Sizes: 10 x 12 mm

VG04636-2 MM Sizes: 13 x 14 mm

VG04636-3 MM Sizes: 15 x 17 mm

VG04639 MM Sizes: 19 x 22 mm

VG04640 MM Sizes: 22 x 24 mm

- ▶ For use with flare nuts and other soft fittings.
- ▶ Heat treated alloy steel.
- ▶ Drop forged for strength.
- ▶ Polished chrome plated finish.

VG04635

MM Sizes: 6 x 8 mm, 8 x 10 mm & 9 x 11 mm.

VG04635

MM Sizes: 10 x 12 mm, 13 x 14 mm & 15 x 17 mm.



RATCHET SPANNER SET

7PC



VG04644

- ▶ Product Material: carbon steel;
- ▶ Size: 8, 10, 12, 13, 14, 15, 17MM
- ▶ MM, *Black finished & polishing;

NEW COMBINATION WRENCHES

7PC

VG04645



- ▶ Product Material: carbon steel;
- ▶ Size: 8, 10, 12, 13, 14, 17, 19MM

STAR DRIVER

- ▶ Ergonomic non slip molded grips for improved comfort and control.
- ▶ Chrome vanadium steel with corrosion resistant satin finish and magnetic tips.
- ▶ Magnetic tips

- VG04480 T10**
- VG04481 T15**
- VG04482 T20**
- VG04483 T25**
- VG04484 T27**
- VG04485 T30**



6 IN 1 MULTI HEAD SCREWDRIVER

VG04490



- ▶ 6 in 1 screwdriver head FR Phillips sizes: #1, #2, #3 and Pozl sizes: #1, #2, #3.
- ▶ Blade is manufactures from S2steel.

6 IN 1 MULTI HEAD SCREWDRIVER WITH 1/4" DR

VG04491



- ▶ 6 in 1 screwdriver head fr Phillips sizes: #1, #2, #3 and Pozl sizes: #1, #2, #3.
- ▶ Blade is manufactures from S2steel.
- ▶ With 1/4"DR fitting for deep sockets.

54 PIECE 3/8" or 1/2" DRIVE HEX, SPLINE & STAR BIT SET

VG04760



- ▶ 14 - HEX BITS
- ▶ 30mm H4, H5, H6, H7, H8, H10, H12
- ▶ 75mm H4, H5, H6, H7, H8, H10, H12
- ▶ 10 - SPLINE BITS
- ▶ 30mm M5, M6, M8, M10, M12
- ▶ 75mm M5, M6, M8, M10, M12
- ▶ 14 - STAR BITS
- ▶ 30mm T20, T25, T30, T40, T45, T50, T55
- ▶ 75mm T20, T25, T30, T40, T45, T50, T55
- ▶ 14 - STAR BITS TAMPER PROOF
- ▶ 30mm T20, T25, T30, T40, T45, T50, T55
- ▶ 75mm T20, T25, T30, T40, T45, T50, T55
- ▶ 2 - BIT ADAPTORS 3/8" & 1/2" Drive

3/8" DR IMPACT DRIVER (4 TIPS)

VG04400



- ▶ Ideal for loosening firmly tightened or rusted screws or bolts.
- ▶ Removable hex adaptor allows use with 3/8" drive sockets & accessories.
- ▶ Heavy duty blow molded storage case.
- ▶ Phillips sizes: #2 & #3
- ▶ Flat sizes: 5/16" & 3/8"

0 - 6" (150MM) STAINLESS STEEL CALIPER

VG04505



- ▶ Measures outside, inside, step and depth.
- ▶ 0" to 6" SAE range.
- ▶ 0mm to 150mm metric range.
- ▶ SAE to metric conversion.
- ▶ Large easy to read LCD display.
- ▶ Zero setting at any position within measuring range.
- ▶ Thumb wheel with lock.
- ▶ Battery included.

DIGITAL CALIPER 0-6" (150MM)

VG04506



- ▶ Measures outside, inside, step and depth.
- ▶ 0" to 6" SAE range.
- ▶ 0mm to 150mm metric range.
- ▶ SAE to metric conversion.
- ▶ Large easy to read LCD display.
- ▶ Zero setting at any position within measuring range.
- ▶ Thumb wheel with lock.
- ▶ Battery included.

6" COMPOSITE DIGITAL CALIPER

VG04507



- ▶ Rugged impact resistant composite material
- ▶ Easy to read SAE and metric LCD display
- ▶ Low battery warning
- ▶ Includes 1.5V button cell battery
- ▶ Specifications: accuracy +/- .001" (.2 mm)
- ▶ Resolution: 0.0005"/0.01 mm
- ▶ Throat depth: 1 9/16"
- ▶ Temperature operating range: 32 deg. F to 104 deg. F
- ▶ Overall length: 9 1/2"



VG04508

FENDER COVER

- ▶ Heavy duty vinyl with foam backing.
- ▶ Convenient built in tool pockets.
- ▶ Fully sewn ribbed edge.
- ▶ Fully sewn ribbed edge.

THICKNESS GAUGE (32 BLADES)

VG04510



- ▶ Decimal and metric sizes.
- ▶ .010" brass blade for transistorized ignitions.
- ▶ SAE Sizes: .0015, .002, .0025, .003, .004, .005, .006, .007, .008, .009, .010, .011, .012, .013, .014, .015, .016, .017, .018, .019, .020, .021, .022, .023, .024, .025, .026, .028, .030, .032, .035"
- ▶ Metric Sizes: .04, .05, .06, .08, .10, .13, .15, .18, .20, .23, .25, .28, .30, .33, .35, .38, .40, .43, .45, .48, .50, .53, .55, .58, .60, .63, .65, .70, .75, .80, .88 mm

THICKNESS GAUGE (15 BLADES)

VG04513



- ▶ Decimal and metric sizes.
- ▶ 3" steel rule.
- ▶ SAE Sizes: .002, .003, .004, .005, .006, .008, .011, .012, .013, .014, .016, .018, .020, .022 and .025"
- ▶ Metric Sizes: .05, .08, .10, .13, .15, .20, .28, .30, .33, .35, .40, .45, .50, .55 and .63 mm

SPARK PLUG GAUGE (8 BLADES)

VG04511



- ▶ Decimal and metric sizes.
- ▶ Electrode adjuster.
- ▶ SAE Sizes: .015, .018, .020, .025, .028, .030, .035 and .040"
- ▶ Metric Sizes: 40, .45, .50, .64, .70, .75, .90 and 1.00 mm

THICKNESS GAUGE (15 BLADES)

VG04512



- ▶ 9 thickness blades 2" long and 6 flat 1" long spark plug blades.
- ▶ Decimal and metric sizes.
- ▶ 2" steel rule.
- ▶ Electrode adjuster.
- ▶ Straight Blade SAE Sizes: .002, .003, .004, .006, .008, .010, .015, .017, .018, .019, .020 and .025"
- ▶ Straight Blade Metric Sizes: .05, .08, .10, .15, .20, .25, .38, .432, .457, .483, .50 and .63 mm
- ▶ Flat Blade SAE Sizes: .020, .025, .028, .030, .035 and .040"
- ▶ Flat Blade Metric Sizes: .50, .64, .70, .75, .88 & 1.02 mm

17 BLADE MINI FEELER GAUGE

VG04514



- ▶ 17 1 1/2" by 1/4" straight blades.
- ▶ SAE Sizes: .010, .012, .013, .015, .016, .017, .018, .019, .020, .022, .024, .025, .026, .028, .030, .032 and .035"

6 BLADE NON MAGNETIC FLR GAUGE

VG04515



- ▶ 6 non magnetic straight brass blades.
- ▶ Check or set clearance between reluctor and pickup coil on electronic ignition distributors.
- ▶ SAE Sizes: .006, .008, .010, .012, .014 and .016"
- ▶ Metric Sizes: .152, .203, .254, .305, .356 and .406 mm

25 BLADE METRIC FEELER GAUGE

VG04516



- ▶ 25 straight blades.
- ▶ Metric Sizes: .04, .05, .06, .07, .08, .09, .10, .15, .20, .25, .30, .35, .40, .45, .50, .55, .60, .65, .70, .75, .80, .85, .90, .95 and 1.00 mm

26 BLADE STANDARD FEELER GAUGE

VG04517



- ▶ Check for accurate clearance on ignition points, valve lash, etc.
- ▶ SAE Sizes: .0015, .002, .0025, .003, .004, .005, .006, .007, .008, .009, .010, .011, .012, .013, .014, .015, .016, .017, .018, .019, .020, .021, .022, .023, .024, .025"
- ▶ Metric Sizes: .038, .051, .064, .076, .102, .127, .152, .178, .203, .229, .254, .279, .305, .330, .356, .381, .406, .432, .457, .483, .508, .533, .559, .584, .610, .635 mm

TAPPET GAUGE (12 BLADES)

VG04519



- ▶ 12 offset tip blades.
- ▶ Decimal and metric sizes.
- ▶ Sizes SAE: .008, .010, .012, .013, .014, .015, .016, .018, .019, .020, .025, .026"
- ▶ Sizes Metric: .203, .254, .305, .330, .356, .381, .406, .457, .483, .508, .635, .660mm

BINATION TUNEUP FEELER GAUGE

VG04518



- ▶ 12 straight steel blades, 6 straight brass blades, 6 wire test loops, electrode adjuster.
- ▶ Decimal and metric sizes. ▶ Useful for tune ups.
- ▶ Steel Blade SAE Sizes: .010, .012, .015, .016, .017, .018, .019, .020, .022, .024, .025 and .026"
- ▶ Steel Blade Metric Sizes: .254, .305, .381, .406, .432, .457, .483, .508, .559, .610, .635 and .660 mm
- ▶ Magnetic Blade SAE Sizes: .006, .008, .010, .012, .014 and .016"
- ▶ Magnetic Blade Metric Sizes: .152, .203, .254, .305, .356 and .406 mm
- ▶ Wire Test Loop SAE Sizes: .025, .030, .034, .035, .040 and .045"

HIGH ENERGY IGNITION TESTER

VG04520



- ▶ Checks for spark in no Start condition.
- ▶ Tests standard, electronic or DIS KV systems.
- ▶ Designed to prevent high energy sparks arching directly to any ground.

WIDE GAP SPARK PLUG & GAP TOOL

VG04523



- ▶ For use with newer autos with high energy engines.
- ▶ Accurately set spark plugs with electrode tool included.
- ▶ 8 durable round wire blades in decimal & metric sizes.
- ▶ SAE Sizes: .025, .030, .035, .040, .044, .054, .060 and .080"
- ▶ Metric Sizes: .635, .762, .889, 1.01, 1.11, 1.37, 1.52 and 2.08 mm

SPARK PLUG GAUGE & GAP TOOL

VG04524



- ▶ Accurately set spark plugs with electrode tool.
- ▶ 7 durable round wire blades in decimal and metric sizes.
- ▶ SAE Sizes: .020, .025, .028, .030, .032, .035 and .040"
- ▶ Metric Sizes: .50, .63, .71, .76, .81, .89, 1.00 mm

TORQUE ANGLE GAUGE

VG04183



- ▶ Used to gauge degree of turn when manufacturer calls for fasteners to be tightened further after torque loads are applied
- ▶ Easy to read
- ▶ Calibrated in degrees
- ▶ 1/2" square drive



SPARK PLUG GAP GAUGE



VG04734

- ▶ Small fishbowl
- ▶ Easy to read markings to set gaps quickly and easily
- ▶ Range: .020 to .100" (.5 to 2.5 mm)
- ▶ Tapered hole adjusts electrode

SIZE CATCHER

VG04682



- ▶ Instantly measure the size of any nut or bolt head;
- ▶ Inch&metric gradations on opposite sides;
- ▶ Metric range: 8to 25mm

INDUCTIVE TIMING LIGHT

VG04795



- ▶ Super bright xenon
- ▶ flash-out brightest yet!

AUTOMOTIVE DIGITAL MULTI-TESTER

- ▶ Checks interior and exterior lights.
- ▶ Find short circuits and bad earths fast.
- ▶ Test power windows and electric motors.
- ▶ Tests continuity in switches, relays, diodes & fuses, and wiring harnesses.
- ▶ Polarity test cables and sockets.
- ▶ Polarity test cables and sockets.



VG04595

NON-CONTACT THERMOMETER

VG04596



- ▶ Temperature range from 0 to 960 degrees F and -18 to 520 degrees C.
- ▶ Measures surface temperature without making contact.
- ▶ Backlight feature.
- ▶ Laser pointer for accurate use.
- ▶ Easy to read large digital display.
- ▶ Check temperature of heater vents, air conditioners, engines, mufflers, tires, brakes and more.

AUTOMOTIVE SHORT AND OPEN FINDER, CAR REPAIR TOOL

VG04597



- ▶ Checking for short circuit
- ▶ Locating open circuit
- ▶ Wire identification
- ▶ Wire tracing

DIGITAL LCD DISPLAY, MAX. READING 3999

VG04598



- ▶ Digital LCD display, Max. reading 3999
- ▶ Data-hold Function
- ▶ Auto Power Off
- ▶ Auto Range
- ▶ Overload Protection

AUTOMOTIVE BATTERY TESTER

VG04599



- ▶ Voltage range: 2.0V/3.0V/4.0V/5.0V/9.0V/12.0V/12.5V/13.5V
- ▶ LED lights up to the Voltage reading
- ▶ Frequency range: 0 to 60Hz

ELECTRONIC STETHOSCOPE

VG04600



- ▶ Sound amplification with volume control.
- ▶ Headset combined with ear defenders to cut out background noise.
- ▶ Short/long probe: long and short shaft reaches tight areas ultra-sensitive mike and amplifier gives full range of sounds needed by the professional.

ELECTRONIC TROUBLESHOOTING KIT

- ▶ Non-contact voltage tester
- ▶ Socket tester
- ▶ Voltage tester
- ▶ All outer surfaces are non-conductive for safety.
- ▶ True ground error indication, socket test, RCD test.

VG04601



HOUSEHOLD TOOL KIT

- ▶ Non-contact voltage tester: non-contact; LED and audible alarm; voltage range: 70V-1000VAC; frequency: 50Hz-60Hz.
- ▶ Stud detector: uses electronic signals to locate the exact position of studs or joists through wall; LED and sounds alarm.
- ▶ Socket Tester: True ground error indication, socket test, RCD test



VG04602

INDUSTRIAL TROUBLESHOOTING KIT

VG04603



- ▶ Contents: Voltage Tester, Digital Clamp Meter, Auto Range Digital Multimeter, Infrared Thermometer (Max. range: 520°C)

ELECTRONIC STETHOSCOPE KIT

- ▶ Combination Electronic Stethoscope Kit.
- ▶ Super sensitive microphone pick-up.
- ▶ Flexible non conductive shaft.
- ▶ Cushioned headphones



VG04605

COMBINATION ELECTRONIC STETHOSCOPE

VG04605A



HIGH RESOLUTION DIGITAL INSPECTION CAMERA WITH RECORDER

VG04608

- ▶ Save images on internal flash memory or SD card (not included).
- ▶ USB cable lets you stream video directly to your laptop or personal computer.
- ▶ Brilliant 3.5" color 320 x 240 display.
- ▶ Narrow 8.5mm probe fits most spark plug holes.
- ▶ 38" watertight flex shaft with CMOS imager.
- ▶ Bright white LED illumination.
- ▶ Rechargeable lithium-ion battery.



FUNCTION DIGITAL MULTIMETER WITH AUDIBLE CONTINUITY

VG04606

- ▶ Test AC/DC voltage, AC/DC current, frequency, resistance, transistor and diode, capacitance, temperature and audible continuity.
- ▶ Features an easy-to-read 3-1/2 digit LCD display. Max. reading 1999.
- ▶ Data hold retains information after test.
- ▶ Automatic zero adjust.



MECHANIC'S STETHOSCOPE

VG04093

- ▶ Super sensitive ear pieces & probe
- ▶ 2 pc metal probe extends to 11-3/4" for hard to reach spots
- ▶ Heavy duty flexible vinyl tubing
- ▶ Shockproof abs handle
- ▶ Effectively locates trouble spots
- ▶ Within engine block



TIRE PRESSURE GAUGE

VG04604

- ▶ This instrument is an ideal tool for measuring tire pressure and tire veins depth.
- ▶ It has the advantages of light weight and compact structure. It is very easy to use.
- ▶ You can use it to measure a vehicle's tire pressure and the tire veins depth for safe driving: Pressure Measurement Range: 3.0 ~ 99.5PSI Pressure Measurement Accuracy: ±1.5PSI Pressure Measurement Resolution: 0.5PSI Units: PSI, BAR, kPa, kg/cm² Power supply: 1.5V, LR44, two pieces



ENGINE MECHANIC'S STETHOSCOPIES

- ▶ Pinpoint engine and chassis noises for easier troubleshooting.
- ▶ Advanced design is more sensitive, covers a wider range of frequencies



VG04605B

DIGITAL INSPECTION CAMERA

VG04607

- ▶ On-screen image reverse and 180° rotation.
- ▶ 38" watertight flex shaft with 16mm CMOS video imager head.
- ▶ Built-in 2.4" color LCD display with sharp 480 x 234 resolution.
- ▶ Capture 640 x 480 JPEG images.
- ▶ Oil and scratch resistant tempered glass lens.
- ▶ Two white LED lamps for low light viewing.



DIGITAL TIRE PRESSURE GAUGE

VG04685

- ▶ Backlit display and convenient lighted tip.
- ▶ Auto off feature: automatically shuts off in 30 seconds when not in use.
- ▶ Triple function display P.S.I., BAR, and kPa.



UNIQUE COMPRESSION TESTER KIT

- ▶ 13" durable rubber hose with 14mm/18mm adapter
- ▶ Easy-reading 2-1/2" diameter gauge features color-coded quadruple calibrations with 0-300psi, 21kg/cm, 21 bar & 2100 kpa.
- ▶ 6" heavy-duty stem with universal rubber cone adapter fits all plug holes.



VG04101

AUTOMATIC WAVE-BOX PRESSURE METER

GAUGE DIAMETER: 2.5"



VG04104

- ▶ Dual gauge reading: 0-300psi (0-21 bar).
- ▶ Designed to check engine oil pressure in both cars and trucks.
- ▶ Easy to read dual scale gauge.
- ▶ Complete with 24" (600mm) of oil proof hose with 1/8NPT.
- ▶ Also includes 1/4"NPT and 3/8"NPT adaptors.

FUEL INJECTION PRESSURE TEST KIT

- ▶ This set includes two gauges for high and low pressure applications.
- ▶ High pressure gauge with dual readings of 0-145psi and 0-1000kpa.
- ▶ Low pressure gauge with 0-15psi or 0-100kpa.
- ▶ Adaptors feature quick couplings for easy connection.
- ▶ Contents: basic testers, test port adaptors, in-line testing tool, in-line testing-banjo fuel bolt adaptors



VG04032

CYLINDER PRESSURE METER

FOR DIESEL TRUCK



VG04102

TU-15

CYLINDER PRESSURE METER

FOR DIESEL TRUCK



VG04103

TU-15

COMPRESSION TESTER KIT

VG04106



- ▶ Quickly and accurately check compression on petrol engines.
- ▶ Thread sizes: M18X1.5, M14X1.25, M10X1.0.

MULTIPLE-FUNCTION OIL COMBUSTION PRESSURE METER

VG04105



- ▶ Model no.: A, AC, D, G, F, Mx2, H, J, HA, I, L, Kx2, KA, KB, KC, B, RK, And IM.

MULTIPLE-FUNCTION OIL COMBUSTION PRESSURE METER

VG04152



- ▶ The set designed for most European car.
- ▶ Pick up the joints and adaptors from #1225.
- ▶ Model No.: A, AC, D, G, F, Mx2, H, J, HA, I, L, Kx2, KA, KB, KC, B, RK & IM
- ▶ All the specification is the same as # 1225.

MULTIPLE-FUNCTION CYLINDER PRESSURE METER

VG04153



QUICK CYLINDER PRESSURE METER

TU-20-1

VG04154



COMPRESSION TEST KIT

- ▶ For direct and indirect engines.
- ▶ Dual scale gauge.
- ▶ Thread chasers M10 M12 M14 M18
- ▶ Extensions M10 M12 M14 M18

VG04030

8PC

- ▶ Includes five adaptors and two thread chasers covering four plug thread sizes.



COMPRESSION TEST KIT

- ▶ For direct and indirect engines.
- ▶ Dual scale gauge.
- ▶ Glow plug adaptors M10X1.0 M18X1.25 M12X1.25 M14X1.25
- ▶ Dummy injectors M20X1.5 M24X2.0
- ▶ Stanadynne dummy.
- ▶ Replacement seal and washer set.
- ▶ 90 degree elbow clamp plate.

12PC

VG04031



DIESEL COMPRESSION TESTER SET

14PC

VG04761



- ▶ Supplied with one gauge and all necessary adapters 24.
- ▶ Gauges includes release valve and 368mm(14.5") of hose, dial reads from 0-1000P

INFLATION GAUGE

VG04689



- ▶ Easy to read 2" inch gauge.
- ▶ Lever throttle with dial gauge.
- ▶ Maximum operation pressure:0-220psi,0-15bar and 0-15000pa
- ▶ Air release button
- ▶ 1/4"npt air inlet
- ▶ Compact size

TYPE INFLATING GUN

VG04690



- ▶ Inflating: fully press inflating trigger.
- ▶ Over pressure release: press the lateral push-button.

HIGH PRECISION DIGITAL/ MECHANICAL TIRE INFLATING GUN

VG04691



- ▶ Operating temperature:-20--+40°C.
- ▶ Accuracy: +1%+1.5Psi.

MINI AIR COMPRESSOR FOR TIRE INFLATING

VG04687



- ▶ Powered by: DC 12V 10A Max
- ▶ Piston DIA:16mm , Single.
- ▶ Output volume: 13-15LPM @ 0PSI
- ▶ MAX pressure: 150PSI (10Bar)
- ▶ Inflating speed: Appr. 8 mins (195/60 R14)

DIGITAL AIR COMPRESSOR FOR TIRE INFLATING

VG04688



- ▶ Powered by: DC 12V 10A Max
- ▶ Piston DIA:16mm , single.
- ▶ Output volume:13-15LPM @ 0PSI
- ▶ MAX pressure:150PSI (10Bar)
- ▶ Inflating speed: Appr. 8 mins (195/60 R14)

AIR COMPRESSOR

VG04686



- ▶ Power supply:DC12V
- ▶ Rated current:30A
- ▶ Max. Pressure:150PSI
- ▶ 2 x 30mm cylinder
- ▶ 2.4M cord with battery clips
- ▶ 5M PU hose

HAND-HELD VACUUM PUMP

- ▶ Easily bleed brakes by yourself.
- ▶ Test automotive vacuum systems.
- ▶ Works on all vehicle makes and models Includes pump with vacuum gauge, Two 2 ft. Lengths of tubing, vacuum Adapters, brake bleeder adapters, Brake fluid reservoir.

VG04098



HAND-HELD VACUUM PUMP



VG04099

- ▶ Easily bleed brakes by yourself.
- ▶ Test automotive vacuum systems.
- ▶ Works on all vehicle makes and models Includes pump with vacuum gauge, Two 2 ft. Lengths of tubing, vacuum Adapters, brake bleeder adapters, Brake fluid reservoir.

HAND-HELD VACUUM PUMP

VG04143



- ▶ Test automotive vacuum systems.
- ▶ Easily bleed brakes by yourself.

VACUUM/PRESSURE PUMP & BRAKE BLEEDING KIT

21PC

VG04100



- ▶ Checks vacuum/pressure operated automotive components.
- ▶ Can be used to bleed hydraulic systems or siphon fluids.
- ▶ Detailed used instructions and photos inside of case.

WATER TANK LEAK DETECTOR

14PC

VG04014



- ▶ Test cooling system for leaks. Includes hand pump, test head in a blow mold case.
- ▶ Suit for: nissan, mitsubishi, mazda subaru, toyota, honda, ford Gm, chrysler, vw, audi,volvo, saab, mercedes benz, bmw, renault,fiat, alfa romeo, infiniti, geo, suzuki, isuzu, lexus, opel, peugeot, jeep, rover, citrom, truck.

WATER TANK LEAK DETECTING INSTRUMENT

VG04750

- ▶ Car overheating too often.
- ▶ Car engine temperature on the high side.
- ▶ This kit has all you need to detect leaks in your car's cooling system external leaks that may have been caused by blown gasket heads, cracked head or block.
- ▶ Can test automotive pressurized cooling systems up to 35 PSI (30 PSI recommended)
- ▶ Pump capacity has large volume that reduces the number of strokes required to pressurize cooling systems.
- ▶ Quick assembly and breakdown with self-locking quick-disconnect components
- ▶ Relief valve is thumb-operated for convenient pressure release
- ▶ Can use on most domestic and import vehicles
- ▶ Includes: 8 radiator cap adapters and convenient carrying case
- ▶ Specifications: Pressure gauge capacity: 0-35 PSI; Hand pump: 7" L x 1-5/8" diameter; Hose: 15" L

BMC 6SETS/CTNS CTN Size: 41"52"31



DELUXE ANTI-FREEZE TESTER

VG04624



- ▶ Easy to read scale & pointer.
- ▶ Tests hot or cold batteries on 6&12 Volt systems.
- ▶ Freezing to boiling points for anti-freeze, calibrated in °C and °F

Blister PACK 72PCS/CTNS CTN Size: 70.4*33.5*58.4

DELUXE BATTERY TESTER

VG04625



- ▶ Easy to read scale & pointer.
- ▶ Tests hot or cold batteries on 6&12 Volt systems.
- ▶ Freezing to boiling points for anti-freeze, calibrated in °C and °F

PRO ANTI-FREEZE TESTER

VG04626



- ▶ Precision calibrated.
- ▶ Color coded indicator float.
- ▶ Acid resistant.

PROFESSIONAL BATTERY TESTER

VG04627



- ▶ Precision calibrated.
- ▶ Color coded indicator float.
- ▶ Acid resistant.

ANTI-FREEZE TESTER

VG04628



- ▶ Color coded balls for easy readings

BATTERY TESTER

VG04629



- ▶ Color coded balls for easy readings

TEMP COMP ANTI-FREEZE TESTER

VG04631



- ▶ Easy to use.
- ▶ Precise color coded glass float indicates anti-freeze content.

DELUXE BATTERY FILLER

VG04632



- ▶ Acid resistant 6 oz. bulb, 6" spout

BRAKE BLEEDER KIT

VG04630



- ▶ Allows one person to quickly and easily bleed air from brake lines.
- ▶ Magnetic pad holds collection bottle to metal frame.
- ▶ Includes adaptors for multiple applications.
- ▶ Detailed instructions on package.

HAND HELD REFRACTOMETER

RHA-503 can be used for measuring the freezing point of either propylene or ethylene glycol based cooling systems. It can also be used for checking the strength of electrolyte solution batteries.

▶ Ethylene Glycol: -50 °C-0°C Propylene Glycol: -50°C-0°C
 Cleaner: -40°C-0°C Battery: 1.100-1.400g
 Resolution: Ethylene Glycol: 5°C Propylene Glycol: 5°C
 Cleaner: 5°C Battery: 0.015g Calibration: zero calibration with water at 20°C Battery: ±0.015g ethylene (propylene) glycol/cleaner: ±5°C

VG04033



RHA-503

1 PINT ALL PURPOSE FUNNEL

VG04575



- ▶ Great for dispensing petroleum based fluids and much more.
- ▶ Extra long neck prevents spills.
- ▶ Easy to use.

18" FUNNEL

VG04576



- ▶ Great for dispensing petroleum based fluids and much more.
- ▶ Extra long neck prevents spills.
- ▶ Easy to use.

1 QUART ALL-PURPOSE FUNNEL

VG04577



- ▶ Great for dispensing petroleum based fluids and much more.
- ▶ Extra long neck prevents spills.
- ▶ Easy to use.

7 QUART DRAIN PAN

VG04584



- ▶ Molded handles and pour spout.
- ▶ Easy to use.
- ▶ Chemical and solvent resistant, won't rust or corrode.
- ▶ Dimensions: 13-1/2" x 11" x 4".

8QT STEEL GALVANIZED FUNNEL

VG04583



- ▶ 8 quart capacity.
- ▶ 12" total height.
- ▶ 9-1/2" diameter
- ▶ 1"OD tip with screen

48OZ PLASTIC FUNNEL

VG04579



- ▶ Durable, oil and gasoline resistant plastic.
- ▶ Safe for all petroleum products, complete with handy storage hanging tabs.
- ▶ Capacity indicates what the funnel will hold when the outlet is blocked

METAL FUNNEL W/12" FLEX SPOUT

VG04571



- ▶ 6 diameter funnel with 12 spout. Zinc plated

Label 24PCS/CTNS CTN Size: 18.3"22.4"51

PLASTIC FUNNEL W/18" SPOUT

VG04572



- ▶ 6 Diameter funnel.
- ▶ 18 Flexible spout.

Label 50PCS/CTNS CTN Size: 41"31.2"46

FLEX FUNNEL WITH HANDLE

VG04573



- ▶ Removable spout for multiple applications.
- ▶ Easy hold handle.

Label 24SETS/CTNS CTN Size: 34"31.2"49

1/2 PINT ALL PURPOSE FUNNEL
VG04574

- ▶ Great for dispensing petroleum based fluids and much more.
- ▶ Extra long neck prevents spills.
- ▶ Easy to use.

2 QUART PLASTIC FUNNEL
VG04580

- ▶ Rugged, corrosion resistant all purpose funnel.
- ▶ Complete with fine mesh straining screen and handy hanging tab.
- ▶ Capacity indicates what the funnel will hold when the outlet is blocked.

2 QT GALVANIZED MEASURING DISP.
VG04581

- ▶ Deluxe measures with spill proof tops.
- ▶ Angled spouts for ease of pouring.
- ▶ Rolled edge, easy grip handles.
- ▶ Calibrated fill line.

5QT FLEX-SPOUT MEASURING DISPEN
VG04582

- ▶ Designed for one hand operation.
- ▶ Thumb operated valve controls flow, flip action locks valve open
- ▶ 14" flexible metal spout with tapered 1/2" OD tip swings into the necessary angle for hard to reach jobs.
- ▶ Recessed bottoms drain fully and guard against puncture.
- ▶ Rolled edge top helps prevent oil spillage.

3-1/2" GAL. GALVANIZED DRAIN PAN
VG04585

- ▶ 16" diameter

COOLANT FILLING TOOL SET
VG04700

- ▶ Quick and easy way to refill coolant during cooling system bleeding process.
- ▶ Quick, efficient and no mess.

BLUE GEN. PURP. LEVER ACTION
VG04591

- ▶ Fits 5 gallon to 55 gallon drums.
- ▶ Ideal for fuel and water based solutions. 9 oz. per 1 stroke.

QUART/GALLON FLUID PUMP
VG04588

- ▶ Unique double threaded cap fits both quart and gallon size containers.
- ▶ Convenient and versatile for hard to reach places.
- ▶ Eliminates mess and waste.

FLUID TRANSFER PUMP SM
VG04589

- ▶ Fits all standard gallon bottles.
- ▶ "Quick Fit" nozzle.
- ▶ Each pump dispenses 1 oz of fluid.
- ▶ Convenient and versatile for hard to reach places.
- ▶ Eliminate mess and waste.

LEVER ACTION DISPENSER
VG04592

- ▶ Perfect for dispensing transmission and other heavier fluids.
- ▶ Contains pump, 4' delivery hose and bucket/barrel cover.
- ▶ Fits most 25 to 50lb buckets.

LIQUID TRANSFER PUMP
VG04720

- ▶ Liquid transfer

MULTI-USE TRANSFER PUMP
VG04144

- ▶ Intake and discharge transfer system.
- ▶ Transfers liquids rapidly.
- ▶ Pumps air or any liquid.
- ▶ 2hoses each 1.3M long.

AIR SYPHON PUMP
950MM
VG04062

- ▶ To suit all containers up to 850mm in depth 950mm delivery hose
- ▶ Durable plastic
- ▶ Useful for transferring wide range of inert liquids

OIL EXTRACTOR WITH PROBES
5 GALLON
VG04051



- ▶ Ideal for cars boats and small aircraft.
- ▶ Set of 6 flexible probes.
- ▶ Level gauge and air pressure regulator with gauge.
- ▶ Self evacuating.
- ▶ Wheels and handle for mobility.

FUEL (PETROL) CADDY
VG04052

- ▶ Holds all many of fluids.
- ▶ Great for diesel fuel - kerosene - transmission fluid.
- ▶ Save time and reduce hassle on your farm - shop - cabin - boathouse - garage.

25 GALLON
DIESEL INJECTOR FLOW TEST KIT COMMON RAIL

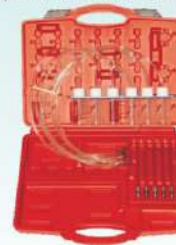
- ▶ Designed to measure return fuel flow on diesel vehicles up to 6 cylinders fitted with common rail injection system.
- ▶ Identifies, worn, blocked or inoperative injectors quickly and easily.
- ▶ Supplied with measurement tubes for short term tests and measurement bottles for long term, more accurate evaluation.

VG04292

VG04293
UNIVERSAL BEARING PACKER

VG04125

- ▶ Evenly injects fresh grease while forcing out old grease.
- ▶ Fits many rollers and ball bearings.
- ▶ Works with most car, boat, trailer and rv bearings.

CLIP REMOVAL PLIER
VG04085

- ▶ Removes door upholstery and other trim items anchors.
- ▶ 2-step tip allows easy access to deep under clip heads to prevent slippage.
- ▶ Spring loaded handle for a great leverage.

SPARK PLUG WIRE PLIERS
VG04081

- ▶ Insulated plier jaws and handles safely remove spark plug wire boots.
- ▶ Offset serrated jaws perfect for accessing hard-to-reach boots.

ANGLE TIP LOCK RING PLIERS
VG04083

- ▶ Removes and installs all types of lock ring on brakes, transmissions, cylinders, clutches, shaft and other applications.
- ▶ Serrated jaws and angled tips for secure grip.

HOSE REMOVER PLIERS
VG04091

- ▶ Easier to use locking feature.
- ▶ Thicker double dipped handle for greater comfort and strength.
- ▶ Tips trap and hold clamp and swivel for multiple angle access.
- ▶ Makes removing and installing ring type clamps easy.

FLAT BAND HOSE CLAMP PLIERS
VG04086

- ▶ Easier to use locking feature.
- ▶ Thicker double dipped handle for greater comfort and strength.
- ▶ Tips trap and hold clamp and swivel for multiple angle access.
- ▶ Makes removing and installing ring type clamps easy.

SWIVEL JAW HOSE CLAMP PLIERS
VG04087

- ▶ Easier to use locking feature.
- ▶ Thicker double dipped handle for greater comfort and strength.
- ▶ Tips trap and hold clamp and swivel for multiple angle access.
- ▶ Makes removing and installing ring type clamps easy.

SWIVEL JAW "+" SLOT HOSE CLAMP PLIERS
VG04088

- ▶ Easier to use locking feature.
- ▶ Thicker double dipped handle for greater comfort and strength.
- ▶ Tips trap and hold clamp and swivel for multiple angle access.
- ▶ Makes removing and installing ring type clamps easy.

ANGLED HOSE CLAMP PLIERS
VG04089

- ▶ Easier to use locking feature.
- ▶ Thicker double dipped handle for greater comfort and strength.
- ▶ Tips trap and hold clamp and swivel for multiple angle access.
- ▶ Makes removing and installing ring type clamps easy.

CLIC-R COLLAR PLIERS
VG04090

- ▶ Easier to use locking feature.
- ▶ Thicker double dipped handle for greater comfort and strength.
- ▶ Tips trap and hold clamp and swivel for multiple angle access.
- ▶ Makes removing and installing ring type clamps easy.

FLEXIBLE HOSE CLAMP
VG04096

- ▶ Allows technician to access the flat-type hose clamps located in hard-to-reach areas.
- ▶ Pliers have locking mechanism to hold clamp in the open position, making removal and installation of clamp easier.
- ▶ Heavy-duty long cable flexes to almost any position.
- ▶ Pliers are spring loaded to the open position.

HOSE CLAMP PLIERS KIT
7PC
VG04020

Hose Clamp Pliers
 Wivel Jaw Hose Clamp Pliers
 Wivel Jaw Hose Clamp Pliers
 Angled Flat Band Hose Clamp Pliers
 Hose Remover Pliers
 Clic-R Collar Pliers
 Flat Band Hose Clamp Pliers

- ▶ Allows for extra reach, removal and locking of clamps into open position.
- ▶ Allows for removal of plastic and/or metal self-tightening hose clamps with diameters of 11/16" - 2-1/2" (18mm-54mm).
- ▶ Precision clamp on end of flexible cable allows for extended reach where other models cannot reach.
- ▶ Pliers can be locked, freeing up your hands and making your job easier and faster.
- ▶ Cable and spring are wearable items and must be replaced.

HOSE CLAMP PLIERS KIT
VG04029
9PC

1PC Hose Clamp Pliers
 1PC Swivel Jaw Spring Wire Clip Pliers.
 1PC Swivel Jaw Band Clip Pliers.
 1PC Angled Flat Band Hose Clamp Pliers
 1PC Hose Remover Pliers
 1PC Clic-R Collar Pliers
 1PC Flat Band Hose Clamp Pliers
 1PC Screwdriver.
 1PC hose remover

- ▶ Allows for extra reach, removal and locking of clamps into open position.
- ▶ Allows for removal of plastic and/or metal self-tightening hose clamps with diameters of 11/16" - 2-1/2" (18mm-54mm).
- ▶ Precision clamp on end of flexible cable allows for extended reach where other models cannot reach.
- ▶ Pliers can be locked, freeing up your hands and making your job easier and faster.
- ▶ Cable and spring are wearable items and must be replaced.

VALVE STEM SEAL PLIER
VG04131

- ▶ Works on both valves still seated or removed.
- ▶ Precision machined seal driving adapters guide the seal for proper setting.

VALVE SEAL REMOVAL & INSTALLER
VG04046

- ▶ Works on both valves still seated or removed.
- ▶ Precision machined seal driving adapters guide the seal for proper setting.
- ▶ Contents:
 1PC valve stem seal plier
 1PC drive handle 6"/150mm long
 2PC deep seal driving sockets for seals O.D. 10.8-14.8mm
 7PC seal driving adapters fit seals 5, 5.5, 6, 6.5, 7, 8mm & 3/8"



FUEL LINE DISCONNECT SET

For uncoupling quick release fittings



VG04225

- ▶ BLUE - 1/4" 5/16" 8mmØ
- ▶ GREEN - 3/8" 10mmØ
- ▶ RED - Special Applications

FLEXIBLE HOSE CLAMP SET

VG04072



3PC

- ▶ Seals heater hose etc. From 1/2" to 3/4" diameter.
- ▶ Great for brake and fuel lines.
- ▶ Radiator hose clamp.

CLUTCH LINE DISCONNECT FORD

VG04623



- ▶ For removing hydraulic clutch lines from clutch slave cylinders on some manual transmissions.
- ▶ Applications: 1989 to current Mercury Cougar and Thunderbird, and 1988 to current small trucks including Explorer, Ranger and Bronco II.
- ▶ 1988 to current small trucks including: Explorer, Ranger & Bronco II

PUSH PIN PLIERS



VG04680

- ▶ Specially designed to remove push pins with center locking pin.
- ▶ Quickly and easily removes plastic anchors without damage.
- ▶ Fits common anchors on Honda, Toyota, GM, Ford, Chrysler and many other makes.

MUFFLER TAILPIPE CUT-OFF TOOL



VG04693

- ▶ Cuts out-of-round pipes, four knife-edged cutting wheels cut quickly, cleanly, track perfectly.
- ▶ Can be operated with one hand-tighteners by turning handle.
- ▶ No overhead linkage to cause needless set-up times or hitting obstructions above tailpipe. Less than 1/3 turn cuts all the way around the pipe.

GREASE GUN ADAPTOR KIT

For use with most manual grease guns. Adaptors and extensions to make almost any lubricating job easy



7PC

- ▶ Push on 90°.
- ▶ Straight extension.
- ▶ 12"/300mm hose extension.
- ▶ 90° slide-on coupler.
- ▶ Rubber tipped nozzle. Needle nozzle.
- ▶ 360° Coupler.

SPARK PLUG WIRE PULLER

VG04407



- ▶ Insulates hands from electric shock
- ▶ Grips boot directly to prevent damage to wire
- ▶ Heavy duty plastic construction.

CV CLAMP TOOL & CV JOINT BOOT CLAMP PLIERS SET



VG04121-D



- ▶ CV Joint clamp banding tool: Effective tool for installing CV clamps. The standard banding tool works with the installer's ratchet and 1/2" socket or use the provided lever to tension the clamp.
- ▶ CV Boot Clamp Pliers: Crimps and flattens ear-type clamps found on CV joint boots installs quick clamps on fuel filter and cooling system hoses.

CV BOOT CLAMP PLIERS

VG04126



- ▶ Crimps and flattens ear-type clamps found on CV joint boots stalls quick clamps on fuel filter and cooling system hoses.

CV JOINT CLAMP BANDING TOOL

VG04121



- ▶ Effective tool for installing CV clamps.
- ▶ The standard banding tool works with the installer's ratchet and 1/2" socket or use the provided lever to tension the clamp.

5PC SNAP RING PLIERS SET

VG04718



- ▶ Ideal for internal and external snap rings.
- ▶ Designed with 4 inter changeable jaws.
- ▶ Two straight jaws, one 45° angle jaw and one 90° angle jaw.

4 PIECES CIRCLIP PLIER SET 13"

VG04792



- ▶ Drop forged and heat treated steel.
- ▶ Black finish & full polished.
- ▶ Deluxe double PVC dipped handle.
- ▶ Contents: 325mm internal - straight 325mm internal - 90° tip 325mm external - straight 325mm external - 90° tip

2PC SNAP RING PLIERS SET

- ▶ Includes 2 extra sets of replaceable 3.5mm diameter 90° tips.
- ▶ Spring ratchet locking mechanism holds against snap ring.
- ▶ Tension for easy handing of large snap ring.
- ▶ Capacity is from 6/12" to 11-3/4".
- ▶ Makes working with large snap rings much easier.
- ▶ Heat-treated tips.

VG04793



4PC SNAP RING PLIERS SET

VG04717

- ▶ Use to install or remove internal and external snap rings.
- ▶ Includes internal straight pliers, internal 45 deg. pliers, external straight and external 45 deg. pliers.
- ▶ Spring loaded for precise movement and control in tight working areas.
- ▶ Chrome molybdenum steel with vinyl coated handles.
- ▶ Tip size is .8"



EXTERNAL SNAP RING PLIERS FOR EXTERNAL SNAP RINGS

VG04712



- ▶ 4 pairs chrome vanadium steel tips for strength and durability.
- ▶ 2 pc Straight tips 0.95, 1.10mm dia, 1 pc 90° tips 1.15mm, 1 pc 45° tips 1.15mm

PISTON RING COMPRESSORS 1/4" DRIVE KEY

- ▶ Quick release button.
- ▶ Made of good quality spring steel.
- ▶ Operated by the 1/4" drive key



3"
VG04057

PROFESSIONAL
53-175MM

6"
VG04058

PROFESSIONAL
60-175MM

4 INCH PISTON RING PLIERS
VG04080

- ▶ Works with piston rings 50-100mm.
- ▶ Universal design can be used on most vehicles.
- ▶ Smooth gripping edge to prevent damage to the piston ring.

6 INCH PISTON RING PLIERS
VG04082

- ▶ Works with piston rings 80-120mm.
- ▶ Universal design can be used on most vehicles.
- ▶ Smooth gripping edge to prevent damage to the piston ring.

8 INCH PISTON RING PLIERS
VG04084

- ▶ Works with piston rings 120-160mm.
- ▶ Universal design can be used on most vehicles.
- ▶ Smooth gripping edge to prevent damage to the piston ring.

ADJUSTABLE PISTON RING INSTALLER
VG04128

- ▶ Removes and installs piston rings on most cars and light trucks and reduces piston ring breakage.
- ▶ Tapered steel jaws.
- ▶ Non-slip, vinyl grip.

WHEEL WEIGHT TOOL
VG04129

- ▶ The best tool for removing or installing passenger car and light truck wheel weights.

WHEEL WEIGHT TOOL
VG04130

- ▶ The best tool for removing or installing passenger car and light truck wheel weights.

PULLEY SPINNING TOOL
VG04346

- ▶ For deep forged pulleys to stop the crankshaft, camshaft, etc.....
- ▶ Applicable: BENZ, VM-Audi, BMW, Ford, Opel, Peugeot, Renault, Rover, Volvo & Japanese Car.

SEAL PULLER
VG04117

- ▶ Easily removes oil and grease seals.
- ▶ Heavy-duty pro style handle.
- ▶ 2 tip sizes reach most seal applications

SPARK PLUG PLIERS
VG04127

- ▶ Insulated plier jaws and handles safely remove spark plug wire boots.
- ▶ Offset serrated jaws perfect for accessing hard-to-reach boots.

FLEX SHAFT CARB ADJUSTER
VG04540

- ▶ 1 1-1/2" flexible shaft.
- ▶ 4 tips: 4.5mm and 1/4".
- ▶ Hex sockets: Double D socket and 3/32" hex bit.
- ▶ Applications include most GM vehicles and 1.7 to 2.2L Chrysler 1978 to present.
- ▶ Tips store in handle or plastic boot.
- ▶ Hex Socket Sizes: 4.5mm & 1/4".
- ▶ Socket Size: Double D.
- ▶ Hex Bit Size: 3/32".

FORD FUEL PUMP RETAINER TOOL
VG04541

- ▶ For proper removal or secure lock down of the fuel pump retaining ring.
- ▶ Reduces the chance of damaging fuel tank, fuel pump or retaining ring.
- ▶ Offset coated handle for sure grip and easy use.
- ▶ Heavy duty construction.

JAW GRIP FILTER WRENCH
VG04550

- ▶ 2-3/4 to 4-1/4 jaw opening.
- ▶ Serrated jaws for maximum grip.
- ▶ Adjustable to fit most filters.

HEAVY DUTY STRAP FILTER WRENCH
VG04551

- ▶ Chrome plated steel bar.
- ▶ Tough no slip strap.
- ▶ Turn with 1/2" ratchet.
- ▶ Fits filters up to 6" in diameter.

DELUXE ADJUSTABLE FILTER WRENCH
VG04552

- ▶ Automatic damping action.
- ▶ Heat treated handle with ribbed design for strength.
- ▶ For imported and domestic cars and trucks.
- ▶ Fits filters 2-1/2" to 3-7/8".

ELECTRONIC STETHOSCOPE
VG04553

- ▶ Vinyl grip.
- ▶ Fits most U.S. and imported cars.
- ▶ Fits filters 2-3/4" to 3-3/4".

UNIVERSAL 3 LEG OIL FILTER WRENCH
VG04564

- ▶ The filter wrench allows easy removal of oil filters even in tight locations of motorcycles.
- ▶ Vinyl dipped grip legs could minimize the possibility of crushing filters.

3 LEG OIL FILTER WRENCH
VG04211

- ▶ Fits popular autos and light trucks.
- ▶ Heat treated carbon steel construction.
- ▶ Tough black oxide finish.
- ▶ Use with 3/8" drive ratchet.
- ▶ Fits filters 2-1/2" to 3-7/8".

3 JAWS OIL FILTER WRENCH
VG04566

- ▶ Removes all oil filters from 2-1/2" to 4" in diameter.
- ▶ Use with 1/2" or 3/8" square drive tool.

UNIVERSAL ADJUSTABLE OIL FILTER WRENCH

- ▶ Fits oil filters from 1-1/2" to 3-1/8".
- ▶ Fits smaller size oil filters, not for use with power tools.
- ▶ Unscrew oil filter and clean mounting base.
- ▶ Apply film of clean oil to filter gasket. Do not use grease.
- ▶ Screw new filter on until gasket reaches base.

VG04212



OIL FILTER WRENCH 3" TO 3-3/4"

VG04555A



- ▶ 3" to 3-3/4".
- ▶ Vinyl grip handle.
- ▶ Studded band for better grip.
- ▶ Removes most spin on type filters.

STRAP WRENCH SET

VG04558



2PC

- ▶ Fits 3/8" to 6-1/2".
- ▶ Features non-slip rubber straps & pvc coated handle for extra grip.

SWIVEL OIL FILTER WRENCH 3-1/2" TO 3-7/8"

- ▶ 3-1/2" to 3-7/8".
- ▶ Swivel handle design provides access in confined areas.
- ▶ Vinyl grip handle.
- ▶ Studded band for better grip.
- ▶ Removes most spin on type filters.

VG04554



OIL FILTER WRENCH

VG04556



- ▶ 2-1/4" to 2-3/4".
- ▶ Wide steel band for extra strength.
- ▶ Vinyl grip handle.
- ▶ Studded band for better grip.
- ▶ Removes most spin on type filters.

CHAIN/BAND FILTER WRENCH 2-3/4"-4-1/2"

VG04559



- ▶ Vinyl grip handle.
- ▶ Studded band and steel chain for better grip.
- ▶ Large range of adjustment up to 4-1/2".

OIL FILTER WRENCH 4" TO 4-3/8"

- ▶ 4" to 4-3/8".
- ▶ Vinyl grip handle.
- ▶ Studded band for better grip.
- ▶ Removes most spin on type filters.

VG04555



OIL FILTER WRENCH

VG04557



- ▶ 2-7/8" to 3-1/8".
- ▶ Wide steel band for extra strength.
- ▶ Vinyl grip handle.
- ▶ Studded band for better grip.
- ▶ Removes most spin on type filters.

OIL FILTER CHAIN WRENCH 1/2" SQ DRIVE 135MM

VG04214



- ▶ Satin finished carbon steel body with 1/2" sq drive for use with ratchet wrench.
- ▶ May also be used with a 20mm spanner.
- ▶ Heavy-duty chain.

20 INCH CHAIN WRENCH

VG04133



- ▶ Effectively wraps around any shape item from 5/8" to 5" in diameter turn with 1/2" square drive tools heavy duty construction.

LARGE OIL FILTER PLIERS

VG04561



- ▶ Comfort grip handles
- ▶ Safety button locks in place
- ▶ Three different positions

CRESCENT CHAIN WRENCH 24 INCH

VG04663



- ▶ Double action allows use in either direction.
- ▶ Designed for confined areas when ordinary pipe wrenches will not fit.
- ▶ Excellent for pipe fittings.
- ▶ Concave cut teeth for improved gripping; easily resharpened if needed.
- ▶ Chrome plated to resist rust.
- ▶ The product brings telescopic functions.

HANG TAB 12PCS/CTNS CTN Size: 46.5"12"17.5

8.5 INCH OIL FILTER CHAIN WRENCH

VG04135



- ▶ Durable aluminum handle.
- ▶ Steel chain for superior grip.

350MM OIL FILTER PLIERS

VG04059



- ▶ Chrome vanadium.
- ▶ Durable baked enamel finish.
- ▶ Quick gripping precision machined jaws.
- ▶ Optimum grip and torque.
- ▶ Fits oil filter elements on most domestic.

SMALL OIL FILTER PLIERS

VG04560



- ▶ Comfort grip handles
- ▶ Safety button locks in place
- ▶ Three different positions

LOCKING OIL FILTER PLIERS

VG04562



- ▶ Heavy-duty jaw grips around work of all shapes.
- ▶ Ideal for tightening, clamping, twisting and turning.
- ▶ Turn screw to adjust pressure and fit work.
- ▶ Ideal for plumbers, mechanics, welders, and others working with large objects.

OIL FILTER WRENCH SET



- ▶ 28 fluted cup type wrenches.
- ▶ 3 leg oil filter wrench 3/8" Dr.
- ▶ 1/2" female to 3/8" male adaptor.
- ▶ Elect-black oxide finish.

VG04048

BMC 4SETS/CTNS CTN Size: 61"37"45.5



CUP TYPE OIL FILTER WRENCH SET

23PC

VG04111



- ▶ Die-cast aluminium alloy cup-type wrench, precision polished.

CUP TYPE OIL FILTER WRENCH SET

15PC

VG04112



- ▶ Die-cast aluminium alloy cup-type wrench, precision polished.

CUP TYPE OIL FILTER WRENCH SET

VG04017

14PC



- ▶ Add 1 pc 3/8" socket.
- ▶ Th250, th251, th252, th253, th254, th255, th256, th257, th258, th259, th260, th261, th262, th263.

OIL FILTER WRENCH SET

VG04228

SPECs:
65/67-14F,
74/76-15F,
76-14F,
93-15F,
76-15F/
80-30F/
93-36F,
3/8"



6PC

Cup type 3/8" Drive

CUP TYPE OIL FILTER WRENCH SET

- ▶ 1 X Ratchet wrench (1 / 2") drive
 - ▶ 1 X ring spanner
 - ▶ 21 Oil filter caps in the following version
- | | | | |
|-----------|-----------|-------------|------------|
| 65mm-14F, | 67mm-14F, | 74mm-14F, | 75mm-15F, |
| 74mm-8F, | 74mm-15F, | 73mm-14F, | 75mm-12F, |
| 74mm-15F, | 79mm-15F, | 73mm-15F, | 74mm-14F, |
| 84mm-18F, | 89mm-15F, | 91mm-15F, | 90mm-15F, |
| 95mm-15F, | 76mm-12F, | 79.5mm-15F, | 101mm-15F, |
| 92mm-15F, | | | |

Die-cast aluminium alloy cup-type wrench, precision polished.

VG04789



4 PIECE END CAP OIL FILTER WRENCHES

VG04545



- ▶ Two-step fluted cap fits a wider range of oil filters.
- ▶ Built in ratchet mechanism.
- ▶ Heavy duty cast aluminum with permanent markings.
- ▶ 3/8" and 3/4" drive
- Sizes: 3-5/32" (80 mm) x 30 flutes, 2-27/32" (65 & 68 mm) x 14 flutes, 3" (74 mm & 76 mm) x 15 flutes, 3-31/32" (93 mm) x 36 flutes

FLUID LINE CLAMPER SET



Size: 3/8", 1/2", 1" & 1-3/4"

VG04715

PWR STEERING PUMP/ALT PULLER

VG04386



- ▶ Removes power steering and alternator pulleys on selected applications of Chrysler, Ford, GM, and Volkswagen with hub sizes of 1 1/8, 1 1/4, 1 5/16 & 1 3/8".
- ▶ Use Performance Tool pulley installer (W87021) to reinstall pulleys on Ford vehicles.
- ▶ Instructions on back of package.

PWR STEERING PUMP PULLEY INST

VG04387



- ▶ Installs pulleys without damage to pump by exerting force only through the shaft.
- ▶ For use on most Ford power steering pump pulleys.



GM PWR STEERING PUMP PULLEY

VG04388



- ▶ Removes and installs GM power steering pump pulleys.
- ▶ Exerts force only through the shaft to prevent damage to pump and pulley.

PROFESSIONAL TUBING BENDER

VG04389



- ▶ Ideal for brass, copper, steel and aluminum.
- ▶ Bends 3/16, 1/4, 5/16 and 3/8" O.D. tubing.
- ▶ Instructions on packaging.

TUBING BENDER

VG04390



- ▶ Heavy duty construction.
- ▶ Four grooves designed to fit popular tubing sizes: 3/16, 1/4, 5/16 and 3/8" O.D.

TAIL PIPE EXPANDER



VG04036

- Small expander 1-1/8" to 1-3/4"
- Medium expander 1-1/2" to 2-1/2"
- Large expander 2-1/8" to 3-1/2"
- ▶ Drop forged, heat-treated steel, designed quickly and easily straighten out clamp dent in mufflers and tail pipes.
- ▶ A simple wrench turn expands pipe for exhaust system repair and installation.
- ▶ Works with all 1-1/8 to 3-1/2 ID. thin-wall pipes.

TWIN CAM LOCKING TOOL

FOR PETROL AND DIESEL ENGINES



VG04061

- ▶ Designed to lock twin camshafts to timing
- ▶ Marks during belt replacement
- ▶ Fits on to sprockets and extends to lock in to sprocket teeth
- ▶ Adjustable arms to fit various diameters and teeth pitches
- ▶ Suitable for locking between cam and diesel injection pump sprockets

OVERHEAD VALVE SPRING COMPRESS

VG04330



- ▶ Conveniently removes valve springs on most cars and light trucks without removing cylinder head.
- ▶ Offset jaws easily grip and compress valve springs.

DIESEL INJECTOR CUTTER SET

VG04777 **7PC**



- ▶ Material: steel & plastic
- ▶ .15mm x 19mm Flat Reamer for Universal injectors
- ▶ .17mm x 17mm Angled Reamer for Benz CDI
- ▶ .17mm x 17mm Flat Reamer for Delphi/Bosch injectors (BMW/PSA/Renault/Ford)
- ▶ .17mm x 19mm Flat Reamer for Bosch injectors (Mercedes CRD)
- ▶ .17mm x 21mm Angled Reamer for Fiat/Iveco
- ▶ T handle 135 x 160mm 23 socket
- ▶ Pilot Hex 19mm x 173.8mm

INJECTOR PULLER SET(DIESEL)

VG04342 **14PC**



- ▶ Sliding Hammer ▶ Handle ▶ Shaft ▶ Ball Joint Adaptor (3 piece)
- ▶ Adaptors - (5 Pieces - 4 internal thread, 1 external thread)
- ▶ External Adaptor - (3 piece) Security Hex Key - 1/2"sq. drive
- ▶ Sockets - (4 pieces - M25, M27, M29, M30 - 1/2"sq. drive)

DIESEL INJECTOR PULLER



- VG04178
- ▶ Assists removal of stubborn BOSCH and LUCAS diesel injectors for saving time when injectors are difficult to remove.
 - ▶ With M8, M12, M14

VAG TDI INJECTOR PULLER SET

7PC



- VG04782
- ▶ Material: steel ▶ designed for the quick and professional extraction of injection
 - ▶ Nozzles and unit-injector(pd) elements from diesel engines. ▶ Suitable for vw-audi diesel engines,
 - ▶ Including:
 - ▶ 1.4 sdi / tdi; 1.9d / sdi / tdi / tdi (pd); 2.0tdi (pd) and (pd 4-valves); 2.5tdi; 2.5tdi (pd); 2.8tdi (pd)
 - ▶ 2.7 / 3.0 tdi (common rail); 4.2tdi (common rail)

VALVE LAPPER TOOL



- VG04220
- ▶ Make sure valves seat perfectly during a top-end rebuild
 - ▶ Easy-grip wood handles for better control
 - ▶ Oil and UV-resistant synthetic rubber cups
 - ▶ Fits sizes 5/8", 13/16", 1-1/8", 1-3/8"

VALVE SPRING COMPRESSOR

Use for car & motorcycle.



- 5-IN-1 VG04022
- Pusher size : 16mm,19mm,23mm,25mm, and 30mm. 5pc pusher for fitting the valve spring correctly and easier to compress the valve spring.

INTERCHANGEABLE-FORK SPRING COMPRESSOR

8PC



VG04027

850kg maximum jaw loading with 4X safety factor. 2 pairs yokes to suit springs from 80mm to 165mm and 155mm to 195mm. Wide availability of spare yokes.

STRUT COIL SPRING COMPRESSOR FOR MERCEDES BENZ

Types 107 W/116 W/123W/124W/126W/129W / 140W/170W/201W/202W/208W/210W and 4-matic include. - Advantage : Newly developed automatic 3-point safety interlock and automatic freewheel at end of stroke.



VG04773

- Telescopic construction range 120mm - 320mm. Plates sizes 90-150mm & 70-130mm.

VALVE SPRING COMPRESSOR



VG04207

- ▶ Removes valve spring in GM and other 8 cylinder engines using stud type rocker arms
- ▶ Compresses spring without removing cylinder head, by simply removing rocker arms and compress the spring by pulling handle

SPRING PRESSURE REGULATOR



VG04023

Drop forged CR-V steel jaws & leaded screws(370mm)both heat treated ensure you obtain professional job performance. The tool is designed for use in limited space under wheel arch. Jaws design is fitting to wrap coil claws for safety. Maximum jaw opening is 370mm.

COILS SPRINGS BOOSTER



VG04139

Up to 1-1/2" lift

REAR TWO-WAY SPRING LOX SET



VG04134

Lock in more resistance to your old, worn -out springs, or decrease resistance to new, stiff springs. Two spring lox to be used on one coil spring to spread coils apart or clamp them together. 3" maximum, 1-1/2" minimum coil spread; 1-1/4" maximum, 3/4" minimum coil compression.

EXHAUST SPRING CLAMP REMOVER



VG04085

- ▶ Removes and replaces steel exhaust clamps for use with volkswagen - audi - seat and skoda vehicles use in conjunction with a 17mm socket or spanner

BRAKE CYLINDER RETAINER REMOVER



VG04146

- ▶ Removes brake cylinder by expanding and holding retainer ring
- ▶ For GM "J" and "X" body cars

BRAKE CALIPER PISTON TOOL SET



VG04132

For use on disc brake calipers fitted to most cars + adaptors No 1/2"

BRAKE SPRING COMPRESSOR



VG04114

- ▶ Remove and install retaining springs 5/8" to 7/8" in diameter.



VG04115

- ▶ Remove and install retaining springs 5/8 to 11/16" in diameter on small car drum brakes.

H'DUTY BRAKE PAD SPREADER TOOL



VG04086

Applications: Alfa, Audi, Fiat, Ford, Nissan, GM (Vauxhall/Opel), Peugeot, Renault, Rover, VW (Porsche)

- ▶ Chemically blackened steel spreader plates.
- ▶ An essential tool for retracting the brake piston to allow insertion of new brake pads.
- ▶ Suitable for most ATE, Bendix, Delco and Girling callipers.
- ▶ Fitted with tommy bar but can be used with 1/2" Sq drive ratchet wrench or spanner.

SPEEDY BRAKE PAD COMPRESSOR



VG04283

- ▶ Compresses Brake Pistons In Seconds.
- ▶ Squeeze the handle and the fast acting plunger compresses disc brake pistons in seconds.
- ▶ Makes brake pad replacement an easy job.

DISK BRAKE PAD SPREADER

VG04094



- ▶ Easily installs pads on most cars
- ▶ Compresses disc brake piston for fast installation



UNIVERSAL CALIPER WIND BACK KIT

21PC

VG04108



▶ Fits most cars.

- ▶ Right hand helix bolt, left hand helix bolt.
- ▶ Winds back brake piston for replacing brake pads.

UNIVERSAL CALIPER WIND BACK KIT

18PC

VG04018



▶ Fits most cars.

- ▶ Right hand helix bolt, left hand helix bolt.
- ▶ Winds back brake piston for replacing brake pads.

UNIVERSAL CALIPER WIND BACK KIT

12PC

VG04019



▶ Fits most cars.

- ▶ Winds back brake piston for replacing brake pads.

UNIVERSAL CALIPER WIND BACK KIT

35PC

VG04282



▶ Fits most cars.

- ▶ Winds back brake piston for replacing brake pads

BRAKE PISTON

VG04047

35PC



- ▶ 24 adaptors and caliper keys
- ▶ Left and right threaded rewind tools
- ▶ 8mm and 7mm hex keys
- ▶ 3mm and 5mm pin punches
- ▶ 4 special reaction plates
- ▶ CV joint grease

BRAKE TOOL SET

VG04026

7PC



- ▶ Complete assortment of tools needed for most drum brake repairs.
- ▶ Brake adjusting tool and blow mold tray.

BRAKE TOOL SET

VG04043

8PC

- ▶ Spring compressor
- ▶ Brake spring installer
- ▶ Spring removal tool
- ▶ Brake retaining spring tool
- ▶ Brake spring pliers
- ▶ Two brake adjustment spoons
- ▶ Mini adjustment spoon

BRAKE SPRING WASHER TOOL

VG04118



- ▶ Removes and installs brake shoe retaining spring washers.
- ▶ Use on both large and small washers.

DISK BRAKE PAD SPREADER

VG04080



- ▶ Easily installs pads on standard and four piston caliper disc brakes

BRAKE CYLINDER HONE

VG04138

3"



Flexible shaft for easy use and self-centering. Knurled nut controls honing tension 51mm through 177mm range. 3" stones.

1-1/8"

VG04137



- ▶ Collar prevents stone breakage.
- ▶ Square ends of stones hone to the end in step-out and blind-end cylinders.
- ▶ Sleeve makes insertion into cylinder easy, protects stone when not in use.

3PC DRUM BRAKE SPRING PLIERS KIT

VG04622



- ▶ Works on most vehicles.
- ▶ Heavy duty hardened steel construction.
- ▶ Brake spring pliers: 13"L
- ▶ Brake adjusting spoon: 8-7/8"L
- ▶ Brake spring remover: 7"L with 3-3/4"L grip

BRAKE SPRING PLIERS

VG04620



- ▶ Easily removes and installs shoe return springs on most drum brakes.
- ▶ Tempered carbon steel for strength and durability.
- ▶ Zinc plated finish resists corrosion.

BRAKE SPRING INSTALLER

VG04704



- ▶ Easily removes and installs brake spring washers.
- ▶ Cutaway portion on tool allows better visual alignment of pin and washer.
- ▶ For use on small and standard brake spring washers.

BRAKE SPOON DRUM BRAKE ADJUSTING

VG04347 9"

VG04347-B 8.5"



- ▶ Ideal for quick and easy brake adjustments
- ▶ Angled ends designed to adapt to many makes and models

DISC BRAKE PISTON REMOVER

VG04078



- Removes and installs disk brake pistons
- Rotates piston back into caliper cylinder
- Use on most imports, Ford, Chrysler and GM cars with four wheel disc brakes
- Use with 3/8" DR. Ratchet

7PC AUTO BODY REPAIR KIT

VG04753



- For pounding auto sheet metal before finishing
- Use on flat and curved surfaces.
- Set includes heavy shrinking hammer, pick and finish hammer, straight pein finishing hammer, heel dolly, utility dolly, double end dolly, and curved dolly.
- Forging processing



7PC AUTO BODY REPAIR KIT

VG04754



- For pounding auto sheet metal before finishing.
- Use on flat and curved surfaces.
- Includes 3 hammers and dollies.

7PC AUTO BODY REPAIR KIT

VG04755



- For pounding auto sheet metal before finishing.
- Use on flat and curved surfaces.
- Set includes heavy shrinking hammer, pick and finish hammer, straight pein finishing hammer, heel dolly, utility dolly, double end dolly, and curved dolly.
- Forging processing

7PC AUTO BODY REPAIR KIT

VG04756



- For pounding auto sheet metal before finishing. Use on flat and curved surfaces.
- Set includes heavy shrinking hammer, pick and finish hammer, straight pein finishing hammer, heel dolly, utility dolly, double end dolly, and curved dolly.
- Bag rubber

REMOVER SET



13PC

VG04286

- Various body and panel beating instruments
- Packed in blow mould case (as displayed)

DOOR HANDLE TOOL-SPRING TOOL

VG04145



- For removing spring clips used to retain door and window handles.
- Allows handle to be removed with the spring clip still on the post.
- Fits GM, Ford and other cars using C type clips.
- Spring steel with comfort grip handle.
- Lifetime warranty.

TRIM PAD REMOVER

VG04205



- Quickly removes most auto body trim pads without damaging trim or stud. This simple tool saves time and effort for vehicle body repairers.
- Made from smooth zinc coated steel.
- Overall length 210mm.

DOOR PANEL & TRIM CLIP REMOVAL TOOL SET

- Rigid stainless steels hafts with a fully polished mirror finish.
- Comprises three door panel and two trim tools.
- U and V profile tips simplify the removal of common types of trim stud and fixing and reduces the risk of damage to surrounding trim.
- Textured comfortable grips with thumb stop and hanging hole.

5PC

VG04215



TRIM TOOL & DOOR SERVICE KIT

VG04076



4PC

- Door Handle Clip Tool
- U-slot-v-mini V- Slot Tools

GM DOOR SPRING TOOL



VG04453



- Alloy steel construction.
- Safely removes and installs door springs on most GM cars and trucks.
- Use with 1/2" wrench or socket.

WINDOW MOLDING REMOVER

4INCH VG04092



- Works with piston rings 50-100mm
- Universal design can be used on most vehicles
- Smooth gripping edge to prevent damage to the piston ring

UNIVERSAL LOCK-OUT TOOL SET
FOR PROFESSIONAL USE ONLY !!

VG04079



- Thin Bar
- Wide Bar
- Wire Form S-Hook
- Slide Lock Tool
- Wonder Tool
- Plastic Coat Hanger
- Fuel Cap Tool
- Wedges

TIRM PAD REMOVER

VG04118



- For quickly releasing door panel and upholstery clips.
- Reduce damage to panels and loss of clips.

DOOR/WINDOW HANDLE CLIP TOOL

VG04621



- Removes and installs door handle and window crank retainer clips on many popular vehicles.

TRIM REMOVER

10 IN 1

VG04140



- Removes door trim, badges, mouldings, headlight clips, windscreen mouldings and weatherstrip.
- Also works as wiper wrench and seam cleaner.

WINDSHIELD REMOVAL TOOL SET

VG04045



- Windshield molding release tool
- Trim pad remover
- Wire feeder tool
- Wire
- Wire gripping handles
- Windshield removal tool

HEAVY-DUTY GASKET

VG04119



- Scraper, durable alloy steel, 1" flat scraper blade for scraping surface before installing gasket.

DELUXE TYRE LEVER
LENGTH: 300MM. WIDTH: 28MM
VG04120



- Quality drop forged and tempered alloy steel with flat round tip.
- Moulded handle enables extra grip.
- Suitable for use with motorcycle, small agricultural or leisure tyres.

WINDOW MOLDING REMOVER
VG04095



- Use to remove wind shields on GM Chrysler and other cars.
- Steel cable pull handle.
- Cuts the butyl adhesive caulking compound around windows with specially designed tempered steel blade.
- Replaceable tempered steel cutting blades can be resharpened.

WINDSHIELD LOCKING STRIP TOOL
VG04123



- Inserts locking strips around windows and windshields.
- Double-ended, 90-degree swivel steel tips fit nearly every application.

HANDY REMOVER SET



VG04073

- Set includes five different sizes and styles of tools that allow easy removal of trim fasteners, molding and wheel hubs.

TRIM REMOVAL SET PROTECTIVE WALLET

- Impact Resistant Nylon
- Non-Scratch
- Ideal Body shop Kit

VG04185



- For removing Automotive Trim, Door Panels and Dashboard Fascias

11PC

TRIM MOLDING REMOVAL TOOL SET



VG04124

- Great tools for trimming work.
- Easy use for plastic upholstery fastener. Be used with ease & without any scratch on body panel and interior mold. Nylon plus fibreglass material is uneasy to be broken and bended.

NONMARRING SCRAPER SET

VG04217



- Remove body side moldings, emblems, gaskets, decals and wheel weights from cars without damage to metal, glass or paint.
- Includes 3/4", 7/8", 1" and 1-1/2" scrapers
- Tough composite construction is strong enough to be hit with a hammer

NYLON PRY BAR INSTALLER KIT
6" LONG

VG04216



- Great for snap in trim removal.
- Strong material won't scratch or gouge your interior
- Includes straight, wedge, offset v-notch, straight v-notch

UTILITY WEDGE SET

VG04074



- For plastic upholstery fastener.
- Extra durability and flexibility due to POM plastic material.
- Working inside vehicle with ease and without damage on interior panel.

EXTENDED SCRAPER

VG04218



- Removes stickers from wind shields and bumpers.
- Spring release changes blades.
- Stores 2 extra steel blades and 3 plastic blades in handle.

3PC BODY FILLER APPLICATOR SET

VG04692B



- Useful for many filler or putty spreading jobs
- Easy to clean
- Just bend applicator and dried filler will pop off

3 PC PLASTIC SPREADERS

VG04692



- 3 convenient sizes: 3-1/2" x 6-1/4", 3" x 5-1/4" & 2-3/4"x4"
- Useful for many filler or putty spreading jobs
- Easy to clean, just bend applicator and dried filler will pop off

4 PC BODY FILLER APPLICATOR SET

VG04406



- Viable spring blades
- Ergonomic composite handles
- With rubber grips
- Blade sizes: 2", 3", 4" and 6"

SINGLE BLADE SCRAPER



VG04730

- Comfort grip handle

NAIL BRUSH IN



VG04738

- Easy grip plastic handle
- Tough, long lasting nylon bristles

RADIO REMOVAL TOOL SET



VG04136

STAINLESS STEEL 20PC

FORD RADIO REMOVAL TOOL



VG04222

- Efficiently releases radio retaining clips and also functions as convenient pull handles.
- Fast, efficient, damage free toradio or dashboard housing.

ELECTRICAL TAPE



VG04736

- UL listed
- 30' rolls
- 7 mil x 3/4"
- Multiple uses around shop, home and auto

CYLINDER SCRAPER SET

VG04224



- ▶ Drop forged heat treated steel for maximum strength.
- ▶ Black oxide finish.
- ▶ The comfortable vinyl grip keeps handle secure even in wet or oily hands.

COTTER PINPULLER

VG04223



- ▶ Removes hard-to-reach pins
- ▶ Rolled hook acts just like a pry bar tool
- ▶ Loosen stub born pins

6PC HOOK & PICK SET

VG04711



- ▶ Includes straight, angled and combination picks
- ▶ Durable double injection molded handles
- ▶ Handy storage tray included
- ▶ Set contents: straight pick, 90 degree pick, double angle pick, complex pick, combination pick and hook pick.

4PC HOOK & PICK SET

VG04710



- ▶ Mark Metal or Plastic
- ▶ Separate Wiring
- ▶ Remove Fuses
- ▶ Pick Up Small Parts and Washers

SCRAPER, HOOK & PICK SET

VG04122



- ▶ Includes (4) mini precision tools & (5) large tools

2PC UTILITY HOOK TOOL SET

VG04075

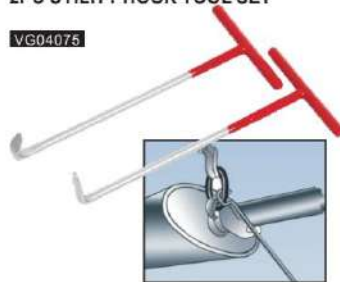

- ▶ Hooked and 90 degree flat
- ▶ Made to install and remove exhaust rubber ring mounts
- ▶ Makes the job much easier than normal
- ▶ Both tools have protection coated T Handles

HEADLIGHT ADJUSTING & BRAKE SPRING HOOK

VG04221



- ▶ Alloy steel, heat-treated construction
- ▶ Removes and installs headlight adjusting springs and brake springs
- ▶ Easy access to hard-to reach areas

LIGHTED INSPECTION TOOL SET

VG04702



- ▶ Includes Super Bright LED, retriever that extends over 27 1/2", and cushion grip handle.
- ▶ 3 AG13 button cell batteries included.
- ▶ Inspection mirror is 2" round.
- ▶ Extends from 6 1/2" to 19", cushion grip handle and convenient pocket clip.

STAINLESS STEEL TELESCOPING INSPECTION MIRROR

VG04705



- ▶ inspection mirror: 2"x3.75"
- ▶ Telescopic from 9.75x26"
- ▶ The material is stainless steel.

STAINLESS STEEL TELESCOPING INSPECTION MIRROR

VG04706



- ▶ inspection mirror: 2"x3.75"
- ▶ Telescopic from 9.75x26"
- ▶ The material is stainless steel.

TELESCOPING MAGNETIC PICK UP TOOL

VG04733



- ▶ Pickup tool telescopes to 25"
- ▶ Convenient pocket clip

PTFE TAPE



VG04737

- ▶ 1/2" x 260"
- ▶ Prevents leaks in plumbing and air lines

TELESCOPING INSPECTION MIRROR

VG04732



- ▶ 1-1/8" round mirror telescopes to 18-1/2"
- ▶ Convenient pocket clip

BATTERY TERM. CLEANER

VG04735



- ▶ All metal construction
- ▶ Quality stainless steel brushes
- ▶ Cleans battery post and terminals

NAIL CLIPPER W/KEY CHAIN

VG04731



- ▶ Keeps a quality nail clipper with file always at hand

24" TELESCOPIC MAG. P/U TOOL

VG04703



- ▶ Telescoping handle extends magnet to 24"
- ▶ Ball joint allows head to swivel 90 degrees.
- ▶ Easily retrieves small parts from confined or hard to reach areas.

2" STICK-ON BLIND SPOT MIRROR

VG04739



GLOVES



not fire proof!

- ▶ Sizes fit a wide range of mechanics
- ▶ Guards hands from cuts, scrapes & burns
- ▶ Designed and tested by mechanics for comfort and durability
- ▶ Thick enough to protect, thin enough to handle small objects
- ▶ Soft, breathable fabric is easy to clean

VG04683 SIZE: L

VG04684 SIZE: X-large

SYNBRIGHT DELUXE A/C CLUTCH HUB PULLER AND INSTALLER KIT AUTOMOTIVE CLUTCH KITS



VG04343
car repair tools Deluxe A/C Clutch Hub Puller & Installer Kit (VT01044) Detailed Specification:
1. Deluxe A/C Clutch Hub Puller & Installer Kit (13pcs)
2. Kit contains a complete offering of A/C compressor clutch hub pullers and installer for GM, Ford, Chrysler and imports. Includes a compressor I.D. chart and comes in a custom molded case.
5sets / 10 / 11 / 0.96'

COMPRESSOR CLUTCH REMOVER KIT



12PC
A/C
VG04040
► Replaces clutches found on F56, C171, 6P & 148 compressors, GM R4 & A6, Hf6, DA-6 & V5 A/C compressors, sanden compressors Sd505, 507, 510, 575, 708 & 709. Etc.....
► 2 & 3 hole puller plate fits most clutches, mechanical force does the pulling.

PULLEY PULLER AND INSTALLER SET



12PC
VG04041
► Remove pressed-on alternator and power steering pulleys on late-model GM, Ford and Chrysler engines etc.....
► The threaded and installs late-model GM alternator and power steering pulleys, including quad 4.

DELUXE A/C CLUTCH HUB PULLER & INSTALLER KIT



VG04109
13PC
Detailed Specification:
1. Deluxe A/C Clutch Hub Puller and Installer Kit (13pcs)
2. Kit contains a complete offering of A/C compressor clutch hub pullers and installer for GM, Ford, Chrysler and imports. Includes a compressor I.D. chart and comes in a custom molded case.
5sets / 10 / 11 / 0.96'

FUEL & TRANSMISSION LINE DISCONNECT SET



21PC
VG04289
Feature: Works on quick connect fuel lines on Ford, GM, and Chrysler, and on the spring lock fuel line couplings on Ford's popular PFI system. They won't damage fuel lines or fuel line connectors. Specification: Work on 5/16", 3/8" and 1/2" fuel line vehicle manufacturer approved and will not damage fittings being disconnected

A/C DISCONNECT TOOL SET



21PC
VG04288
Removing and disconnecting tools for pipe connectors. For air conditioning, fuel, air and oil pipes. Fits nearly all brands.

FUEL & TRANSMISSION LINE DISCONNECT SET



8PC
VG04016
► Includes: 1PC oil cooler line disconnect tool
► 3pc 5/16" 1/4" 3/8" aluminum disconnect tool
► 1pc fuel line disconnect tool
► 1pc ea. 5/16" and 3/8" fuel line disconnect tool
► Disconnects fuel, air conditioning and transmission lines. simple push-on, pull-off action.

8 PC MASTER LINE DISCONNECT



VG04548

6 PC A/C & FUEL LINE QUICK



VG04547
► Color coded compact size for quick selection and easy storage.
► Instructions for use on package
► Sizes: 5/16, 3/8, 1/2, 5/8, 3/4 and 7/8"

SCIS. TYPE FORD FUEL & A/C LINE



VG04543
► Easily separates spring coupling fittings on fuel lines and air conditioning systems on 1981 to current Ford and Chrysler LH Series.
► Sizes: .095, 1.27, 1.6 and 1.9mm

FUEL LINE DISCONNECT TOOL



VG04184
► Releases the fuel line locking mechanism on 1989 and newer GM vehicles, 1990 and newer Ford vehicles, and some 1990 and newer Mazda vehicles

COMMON COOL GAS METER



VG04107
High pressure: 0-500psi
0-35kg/cm
low pressure: 0-120psi
1-8.5kg/cm
► R-134a sight glass manifold with 3X60" color hoses.
► With sight glasses. ► Vacuum: 0-30in/Hg

CONDENSER FIN COMB



VG04219
► Straightens bent fins on a/c condensers and radiators to increase air flow
Capacity: 8,9,10,12,14&15 spacing per inch



FUEL, TRAN & A/C DISCON. TOOL



VG04546
Easily separates quick disconnect style fittings on the following: Ford - EFI fuel lines with hair pin connectors. Transmission cooler lines on the following: 1987 to current - Buick Riviera and Reatta, Cadillac Concours, Eldorado, Seville and Old Toronado. 1989 to current - GM 1/2 ton, 3/4 ton and 1 ton pickups.

DISCONNECT TOOL SET



9PC
VG04069
► These disconnect tools you need to work with spring locking coupling, fuel line, and transmission cooler line.

A/C DISCONNECT TOOL SET



4PC
VG04071
► These tools service heater hoses, transmission oil coolers, air conditioning and fuel lines.

DISASSEMBLER COOL OIL PIPE COOL OIL PIPE



6PC
7/8" 3/4" 5/8" 1/2" 3/8" 5/16"
VAG, KIA, HYUNDAI, FORD, GM, DODGE
VG04070

**RE-THREADING KIT
42PC**

VG04035

- ▶ Metric taps
- ▶ Thread file 9 10 12 16 20 27 28 32
- ▶ Thread file 11 12 13 14 15 16 18 20 24
- ▶ Includes right and left side spindle



OIL PAN THREAD REPAIR SET

VG04155

▶ 24PC PLUS WASHERS

▶ CHROME-VANADIUM TAPS
▶ M13 M15 M17 M20

- ▶ Oil drain plugs may need to be replaced because of stripped threads.
- ▶ This set could save € 100s in repair bills - no need for welding.
- ▶ Simply re-tap hole and replace drain plug.
- ▶ Suitable for cars, motorcycles, trucks and vans



OIL PAN THREAD REPAIR SET

- ▶ Disassemble the damaged oil drain screw.
- ▶ Use a tool operating the tap to enlarge the diameter of oil drain hole.
- ▶ Take a washer through the new oil drain plug, and then insert a new oil drain plug.



6 PCS OIL DRAIN PLUG 6 PCS WASHER

VG04166 (13mm)

VG04167 (15mm)



6 PCS OIL DRAIN PLUG 6 PCS WASHER

VG04168 (17mm)

VG04169 (20mm)

HELICOIL TYPE THREAD INSERTS



▶ Replacement thread insert coil packs for use with Silverline thread repair kits

VG04186A	25PC M5x0.8mm	VG04186D	25PC M10X1.5
VG04186B	25PC M6X1.0	VG04186E	10PC M12X1.75
VG04186C	25PC M8X1.25		



Ideal for restoring damaged threads, suitable for engine repair and other automotive applications

THREAD REPAIR SET

VG04170

- ▶ 3 Installation Tools
- ▶ 3 Break Pin Tools
- ▶ 3 Twist Drills
- ▶ 1 Hex Key
- ▶ 3 Taps
- ▶ 75 wire thread inserts

SIZE:
▶ M6 X 1.0 X 8.0mm
▶ M6 X 1.25 X 10.8mm
▶ M10 X 1.25 X 13.5mm



VG04044

- ▶ 5 Installation Tools
- ▶ 5 Break Pin Tools
- ▶ 5 Twist Drills
- ▶ 1 Hex Key
- ▶ 5 Taps
- ▶ 110 wire thread inserts

SIZE:
▶ M5 X 0.8 X 6.7mm
▶ M6 X 1.0 X 10.8mm
▶ M8 X 1.25 X 10.8mm
▶ M10 X 1.5 X 13.5mm
▶ M12 X 1.75 X 16.3mm

- ▶ 10/20 PCS wire thread inserts
- ▶ 1 PC Installation Tools
- ▶ 1 PC Break Pin Tools
- ▶ 1 PC Twist Drills
- ▶ 1 PC Hex Key
- ▶ 1 PC Taps



25 PIECE THREAD REPAIR KIT

VG04156 M5 X 0.8 X 6.7mm
VG04157 M6 X 1.0 X 8.0mm
VG04158 M8 X 1.25 X 10.8mm

15 PIECE THREAD REPAIR KIT

VG04159 M10 X 1.0 X 13.5mm
VG04160 M10 X 1.25 X 13.5mm
VG04161 M10 X 1.5 X 13.5mm
VG04162 M12 X 1.25 X 16.3mm
VG04163 M12 X 1.5 X 16.3mm
VG04164 M12 X 1.75 X 16.3mm
VG04165 M14 X 1.25 X 12.4mm

- ▶ 10/20 PCS wire thread inserts
- ▶ 1 PC Installation Tools
- ▶ 1 PC Break Pin Tools
- ▶ 1 PC Twist Drills
- ▶ 1 PC Hex Key
- ▶ 1 PC Taps



25 PIECE THREAD REPAIR KIT

VG04187A M5 X 0.8 X 6.7mm
VG04187B M6 X 1.0 X 8.0mm
VG04187C M8 X 1.25 X 10.8mm

15 PIECE THREAD REPAIR KIT

VG04187D M10 X 1.0 X 13.5mm
VG04187E M10 X 1.25 X 13.5mm
VG04187F M10 X 1.5 X 13.5mm
VG04187G M12 X 1.25 X 16.3mm
VG04187H M12 X 1.5 X 16.3mm
VG04187J M12 X 1.75 X 16.3mm
VG04187K M14 X 1.25 X 12.4mm
VG04187L M14 X 1.5 X 12.4mm

534PC



OIL DRAIN PLUG SCREWS & ALUM. O-RING SET

O-RINGS SCREWS

- ▶ 50 X 6mm
- ▶ 50 X 8mm
- ▶ 50 X 10mm
- ▶ 50 X 12mm
- ▶ 50 X 13mm
- ▶ 50 X 14mm
- ▶ 50 X 15mm
- ▶ 50 X 16mm
- ▶ 50 X 18mm
- ▶ 50 X 20mm
- ▶ 5 X M10
- ▶ 5 X M12
- ▶ 5 X M13
- ▶ 5 X M14
- ▶ 5 X M15
- ▶ 3 X M16
- ▶ 3 X M18
- ▶ 3 X M20

VG04725



QUADRILATERAL AND HEX OIL DRAINER

12PC



VG04177

- ▶ For removal replacement of oil drain plugs.

CHAIN BREAKER AND RIVETING TOOLS



VG04786

- ▶ This kit includes 3 pin sizes to fit a variety of chains.
- ▶ This tool will break and rivet 420-630 rear drive chains.
- ▶ It comes with 2mm, 3mm, 4mm, replacement tips for different size cam chains.
- ▶ Cam chain breaker riveter-breaks and rivets/stakes all over head cam chains on all model Japanese and European CHV cam chains

CHAIN PIPE CUTTER

VG04775



- ▶ Product Description:
- ▶ Exhaust and Tailpipe Cutter
- ▶ 19mm diameter Cutters to Eliminate Bottoming Out
- ▶ Cuts Thin and Thick Walled Pipe from 3/4 inch to 3.25 inch / 19mm to 83mm Diameter
- ▶ Gets Into Tight Spots for Easy Cutting
- ▶ Only 1/4 Turn for Complete Cut
- ▶ Cutting Wheels on Every Pivot for Smooth Tracking

1/2DR 17" FLEX HANDLE



VG04656

- ▶ High torque non-slip grips
- ▶ Quick release
- ▶ 1/4" drive has 43 gear teeth, 3/8" and 1/2" drives have 72 gear teeth
- ▶ Black oxide coated drive surfaces for long life
- ▶ Contains: 1 pc each 1/4, 3/8 and 1/2" drive thumbwheel ratche

BASIC DATA SHEET



- ▶ Suitable for use on crankshafts, alternatrs, air conditionis units & water pumps

VG04776

UNIVERSAL HOLDERS

VG04142



- ▶ Dipping-plastic handle.
- ▶ Heat treated.
- ▶ Black treated.

UNIVERSAL ENGINE LIFT PLATE

VG04450

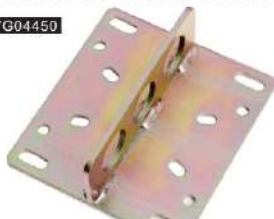

- ▶ Universal design fits more than 90% of common applications including Dominator manifolds.
- ▶ Makes removing or installing engines with or without the transmission easy.
- ▶ 1,000 lbs. maximum load.
- ▶ Dominator is a registered trademark of Holley Performance Products, Inc.

ENGINE LIFT CHAIN

VG04451



- ▶ 1,000 lb. maximum load.
- ▶ 24" chain, 28" overall length.

UNIVERSAL HOLDERS

36-110mm

VG04141



- ▶ Dipping-plastic handle.
- ▶ Heat treated.
- ▶ Black treated.
- ▶ Work range: 36-110mm.

EMERGENCY AUTO SAFETY TOOL

- ▶ Bright LED flashlight
- ▶ Magnetic base holds the tool to any steel surface
- ▶ Powered by two "AA" batteries (not included)



Bright LED flashlight 9 flashing red LED lights Seat belt cutter



Glass breaker Magnetic base



VG04695

12V 3.5 M CP SPOTLIGHT

VG04694



- ▶ 3.5 Million candle power
- ▶ Super bright 100 watt H3 quartz halogen bulb
- ▶ Removable red lens to protect light vision
- ▶ Compact design with ergonomic grip
- ▶ 6 ft coiled cord with 12V fused power plug
- ▶ Perfect for RV's, trucks, boats & ATV's

ADJUSTABLE WHEEL BEARING LOCK NUT WRENCH

VG04181



- ▶ Adjustable jaws with locking feature to suit both hexagon & octagon wheel bearing lock nuts. Includes three sets of pins to suit lock nuts with pin holes.
- ▶ Capacity:
6PT lock nuts: 1-3/4" to 5-3/4" (49-135mm)
8PT lock nuts: 1-3/4" to 5-5/8" (49-143mm)
Pin diameters: 1/4"(6mm), 5/16"(8mm), 3/8"(10mm)

SELF ADJUSTING CLUTCH TOOL SET

VG04752



- ▶ Necessary for pre-tensioning self adjusting clutches before removal or installation.
- ▶ Prevents plate distortion which may prevent the clutch from disengaging or cause dragging.
- ▶ Features a refitting tool, allowing the clutch adjuster to be wound back, and six alignment adaptors.
- ▶ Alignment adaptor sizes:
15/23mm, 15/28mm, 15/34mm, 21/23mm, 20/23mm, 14&15/20mm
- ▶ Assembly Flywheel Threads:
6x1.00mm, 7x1.00mm, 8x1.25mm

PRESS AND PULL SLEEVE KIT

Ideal for different vehicles. Cars + HGVs. Universal tool set for extracting and drawing in.

VG04751



- ▶ Silent bearings, hydraulic bearings, bearing bushes, ball bearings, shaft seals, rubber bearings, etc.
- ▶ Fully universal application. Depending on requirements, the particular sleeves can also be individually reworked(e.g. recess, etc.)
- ▶ Application also with workshop press +press frame.
- ▶ 22 X Press-on sleeves
Inside: Diameter 34, 36, 38, 40, 42, 44, 46, 48, 50, 52, 54, 56, 58, 60, 62, 64, 66, 68, 70, 72, 75, 80 mm
Outside: Diameter 44, 46, 48, 50, 52, 54, 56, 58, 60, 62, 64, 66, 68, 70, 72, 74, 76, 78, 80, 82, 85, 90mm
- ▶ 5 X Pulling spindle + Nuts
Sizes: M10, M12, M14, M16, M18

FORD REAR SUSPENSION BUSH TOOL

VG04179



- ▶ A specially designed tool for removing and installing the rear subframe.
- ▶ Applicable: Ford Mondeo.

VW, AUDI REAR SUSPENSION TOOL

VG04180



- ▶ Special designed for replacing the rear axle mounting bushes, whilst in site on the vehicle and without the need for removing the rear axle assembly.
- ▶ It's fine thread and thrust bearing allows the bush to be fitted quickly and easily without causing damage.
- ▶ Applicable: Audi A3/VW Golf IV/ Bora 1.4/ 1.6/ 1.8 / 2.0 and 1.9d(2001-2003)

BUSH EXTRACTOR WITH MECHANICAL

VG04770

8PC



- ▶ Suitable for VW Polo (9N) front-axle bracket wishbone silent blocs.
- ▶ The removal and replacement of the silent bloc placed in dir brackets easily and safely carried out directly on the vehicle by using the extractor.

BUSH EXTRACTOR WITH MECHANICAL

VW/POLO/AUDI

13PC



VG04771

- Suitable for VW Polo (9N) front-axle bracket wishbone silent blocs.
- The removal and replacement of the silent bloc placed in dir bracket is easily and safely carried out directly on the vehicle by using the extractor.

REAR SUSPENSION BUSH REMOVAL TOOL - OPEL VAUXHALL

VG04787



- For removing and replacing rear upper and lower bushes on trailing arm suspensions.
- Applicable: Opel Vauxhall model.

TIMING KIT FOR DIESEL ENGINES "LAND ROVER"

VG04038

- Crankshaft damper puller
- Injection pump gear locking tool
- Injection pump timing pin
- 200-300 tdi
- Flywheel timing tool
- 200-300 tdi
- Ps pump timing tool-2.5
- Flywheel timing tool-2.5
- Edc timing pin -30q

12PC



BELT TOOL KIT FOR ELASTIC - RIBBED BELTS

VG04765



- Suitable for engines with elastic ribbed belts such as Alfa Romeo, BMW, Chrysler, Fiat, Ford, Mercedes, PSA, Seat, Skoda, Smart, Volvo, VW-Audi, etc.
- The tool set is the quick and easy removal and installation of the new elastic ribbed belts required.

TIMING LOCKING SET

VG04015



- Timing locking
- fly wheel holding

8PC

TIMING LOCKING TOOL SET



19PC

This set of tools can correct engine timing when replacing the timing belt.
Suitable: ISUZU, MAZDA, HONDA, FORD OPEL, AAB, LANDROVER, CITROEN, PEUGEOT, VW etc.

ENGINE TIMING TOOL SET

-FIAT & OPEL

VG04173



This comprehensive set of tools enables the correct engine timing to be made when replacing the timing belt.
Applicable: FIAT & OPEL

ENGINE TIMING TOOL SET

-RENAULT

VG04175



This new camshaft pulley setting tool holds two pulleys in place while changing the cam belt and correct engine timing to be performed when changing the timing belt.
Applicable: Renault 16V & K4J, K4M & F4P, F4R.

ENGINE TIMING TOOL SET

-FORD & MAZDA

VG04174



This comprehensive set of tools enables the correct engine timing to be made when replacing the timing belt.
Applicable: FORD & MAZDA

TIMING TOOL KIT

FOR OPEL VAUXHALL (GM)

- Locking the camshaft and crankshaft.
- Removal and assembly of fuel injection pump and water pump.
- Changing the timing belt.
- Also suitable for identical engines in e.g.: Saab, Renault, etc.
- Dieselmotoren: 1.3CDTI, 16V, 1.9CDTI, 2.0 DTI, 2.2 DTI
- Passend for z.B.: Agila, Astra, Combo-C, Corsa, Frontera, Omega, Signia, Sintra, Tigra, Vectra, Zafira

VG04290

26PC



ENGINE TIMING TOOLS

VW & AUDI W/ 4 GROOVES & ALU FINISH

VG04291

- AUDI: A4, A6, A8, A11 year (97-04)
- VW: passat (98-04)
- ENGINES CODES: AFB, AKE, AKN, AYM, BAU, BCZ, BDG, BDH, BFC, 2PCS 4 grooves & alu finish locking tools (take out 4PCS & add 2PCS; add 6CS more).
- This new kit of twelve tools is required for petrol & diesel engine service including timing belt replacement on recent models & also older 1.9D models from 1986.



TIMING TOOL KIT

-RENAULT

VG04295

- | | |
|-----------------------|------------------------------|
| POINT: | Megane 2.5 D/TD |
| Clio 1.2 / 1.4 | Megane 1.4 / 1.6 / 2.0 / 16v |
| Clio 1.4/1.6/1.8 16v | R19 1.4 |
| Clio Sport 2.0 16v | R19 1.4eco |
| Clio Williams 2.0 16v | R19 1.8 16v |
| Espace 2.0 | Rapid 1.4 |
| Espace 2.0 16v | Safrane 2.0 16v |
| Espace 2.2 TD | Safrane 2.2 TD |
| Express 1.4 | Safrane 2.5 20v |
| Extra 1.4 | Scenic 1.4/1.8/2.0 16v |
| kangoo 1.2/1.4 | Trafic 2.5D |
| Laguna 1.6 16v | |
| Laguna 1.8/2.0 16v | |
| Laguna 2.2 D/TD | |
| Laguna 2.5D/TD | |



ATTREZZO MESSA IN FASE TOOL

VG04294



- For Camshaft Regulation Renault Espace 2.2 Dci-Master 2.2/2.5dci



ENGINE TIMING TOOL SET

FOR PROFESSIONAL ENGINE REPAIR

VG04296

- Petro Engines: FIAT Brava, Bravo, Barchetta, Cargo, Coupe, Marea, Palio, Weekend, Punto, Multipla, Stilo, Idea Doble, Twin Can Engines 1.2 1.4 1.6 1.8 16V
- Diesel Engines: FIAT Brava, Doble, Ulysse, Ducato, Stilo, JTD Diesel Engines 1.9 D/TD, 1.9JTD, 2.4TD/JTD

ENGINE TIMING TOOL SET

FOR FOCUS CMAX

VG04297



- This five piece set is essential for replacing the cam belt on Ford Focus/Cmax 1.6Ti-VCT with engine code HXDA/2003-2007 plus 2.0TDCI with engine codes G6DA, G6DB, G6DC 2003.
- Set includes Camshaft Sprocket Holding Tool, Tensioner Pulley Locking Pin, Flywheel timing Pin, Crankshaft timing pin, Camshaft Sprocket Locking Tool.
- Also required Flywheel Locking Tool and adaptors

TIMING TOOL SET

FOR OPEL & VAUXHALL (GM)

VG04299



- Changing the timing belt suitable for identical engines in e.g. Saab, Renault, etc.
- Locking the camshaft and crankshaft
- Diesel engine: 1.3CDT, 1.6V, 1.9CDT, 2.0DT, 2.2DT
- Application for Agila, Combo-C, Corsa, Frontera, Omega, Sintra, Tigra, Petrol engine 1.0 12V/1.2 16V (since 97) 1.4/1.6 1.8/2.0 2.2 16V (since 05)
- Application for Agila, Astra, Corsa, Frontera, Omega, Sintra, Speedster, Tigra, Vectra, Zafira.

**ENGINE TIMING TOOL SET
- CITROEN & PEUGEOT**



VG04176

- ▶ This comprehensive set of tools enables the correct engine timing to be made when replacing the timing belt.
- ▶ Applicable: Citroen and Peugeot with either HPI (Petrol) or HDi (Diesel) engines

**ENGINE TIMING TOOL SET
VW-1.2L**

VG04182



- ▶ Installing and removal of camshaft / variable camshaft timing unit. Checking and adjustment of timing.
- ▶ Applicable: Petrol engines: VW Polo, Fox, Skoda Fabia, SEAT Ibiza/ Cordoba 1.2L engine, 2 and 3 cylinder, 6/12 V

**CAMSHAFT ALIGNMENT TOOL
VW, AUDI**

VG04171



- ▶ Special designed to set camshaft in the correct position.
- ▶ Applicable: VW: Passat(98-04) AUDI: A4, A6, A8, A11 road(97-04)

**TIMING TOOL
BMW(M47)**

VG04172



- ▶ Special design for correcting timing to be made when servicing BMW M47 2.0 16v engines.
- ▶ Applicable: BMW M47 engines.

**PETROL ENGINE TIMING KIT
- OPEL & VAUXHALL 1.0 1.2 1.4**

VG04779



- Material: steel & plastic
- Kit includes all the locking tools to time the chain on 1.0 1.2 1.4 ecotec twin cam engines
- Also includes the timing disc position gauge for positioning the timing sensor disc fitted to the inlet camshaft

**TIMING LOCKING TOOL SET
-FOR BMW MIN ONE/COOPER/COOPERS**

VG04790



- Includes:
 - ▶ Camshaft sprocket holding tool
 - ▶ Engine support bracket
 - ▶ Tensioner assembly tool

**ENGINE TIMING LOCKING TOOL SET
FOR FORD & MAZDA**

VG04298



- ▶ Applicable for FORD 1.8 Di TD/ TDCI diesel & 1.25-2.0 16v zetec petrol engine e.g FORD Fiesta, Focus/Oroun, Focus, Puma, Sierra, Modeo, Cougar, Couler/Kombi, P100 and Mazda121.
- ▶ Designed for pulling off the camshaft timing belt wheel and locking or positioning the engine output shafts such as the camshaft and the crankshaft.
- ▶ Required for changing the timing belt or for engine.

**ENGINE TIMING TOOL SET
-VW & AUDI**

VG04772



- This kit of twelve tools is required for petrol & diesel engine service including timing belt replacement on recent models & also older 1.9D models from 1976; Models: AUDI: A4, A6, A8, A11 road (97-04); VW: passat: (98-04); Engines codes: AFB, KE, AKN, AYM, BAU, BCZ, BDG, BDH, BFC.

ENGINE TIMING TOOL SET

VG04785



- This comprehensive set of tools enables the correct timing positions to be achieved on both camshaft and crankshaft whilst replacing the timing belt or chain on both petrol and diesel engines.
- Special wrench for controlled turning of the exhaust camshaft sprocket when removing and installing the VANOS unit.
- Primary timing chain pre-load tool for tensioning the timing chain on M50 engines. M22 threaded for M42/M60 engines. M26 threaded for M50/M52 engines.

**TIMING BELT TENSION SETTING TOOL
WITH 4PCS 3/8". DR. SOCKETS**



- ▶ Setting tool 3/8". and 1/2". drive
- ▶ 3/8". drive sockets 13-15-16-18mm
- ▶ For engine compartments with restricted access

VG04068

VG04068-B

**STRUT COIL SPRING COMPRESSOR
HYDRAULIC**

VG04053

- For use with 100mm to 250mm springs - ram travel 340mm - max working length 590mm
- strut shaft clasp adjusts and will secure the strut during operation
- Max capacity 2 tons
- Extended height: 750mm



2 TONS

**STRUT COIL SPRING COMPRESSOR STATION
HYDRAULIC**

VG04054

- ▶ 1000kg foot operated hydraulic unit
- ▶ Quicker and easier than using ratchet driven
- ▶ Spring compressor
- ▶ Plastic coated yokes reduce the risk of spring slippage or damage and are suitable for springs from 102mm to 160mm diameter



AIR HYDRAULIC STRUT COIL SPRING COMPRESSOR STATION

VG04055

- ▶ 1000kg capacity
- ▶ Air actuated hydraulic unit with alternative foot operation
- ▶ Quicker and easier than using ratchet driven
- ▶ Spring compressor
- ▶ Plastic coated yokes reduce the risk of spring slippage or damage
- ▶ Suitable for springs from 102mm to 160mm diameter



WHEEL BALANCER

VG04056

- Bulls eye level for easy measure
- Machined aluminium head accepts hub
- Rust resistant enamel finished base
- Overall dimensions height 22.5/8in. Diameter 11.7/8in.



STANDARD ACCESSORIES FOR TYRE MENDING MACHINE

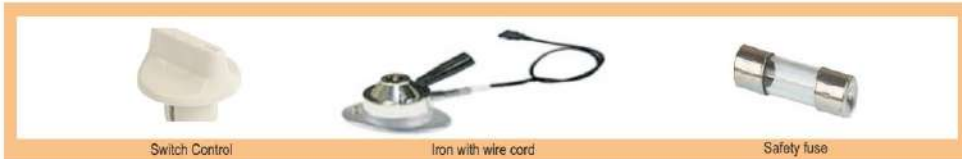

Switch Control

Iron with wire cord

Safety fuse

OPTIONAL ACCESSORIES FOR TYRE MENDING MACHINE



Timer

On-off Switch(Single way)

On-off Switch(Double way)

Rubber Pad

TUBE PLATE MENDING MACHINE

VG04199 SK100

This machine will make a better repair on the most common sized of tube at a lower cost than any other method.

- ⊙ 220/240V-50/60HZ, 500W.
- ⊙ Working temperature: 180° C
- ⊙ Heating unit dimension: 10 × 17cm.
- ⊙ Heat unit with snap-type thermostat reaches curing temperature fast.
- ⊙ Controlling with auto time & temperature adaptor.

Auto distance and wheel diameter measuring



TUBE PLATE MENDING MACHINE

VG04200 SK120

This machine will make a better repair on the most common sized of tube at a lower cost than any other method.

- ⊙ 220/240V-50/60HZ, 2 × 500W.
- ⊙ Working temperature: 165° C
- ⊙ Heating unit dimension: 10 × 17cm.
- ⊙ Heat unit with snap-type thermostat reaches curing temperature fast.
- ⊙ Controlling with auto time & temperature adaptor.

**PROFESSIONAL
2X500W**



TUBE PLATE MENDING MACHINE

VG04201 SK200

This machine will make a better repair on the most common sized of tube at a lower cost than any other method.

- ⊙ 220/240V-50/60HZ, 500W.
- ⊙ Working temperature: 180° C
- ⊙ Heating unit dimension: 10 × 17cm.
- ⊙ Heat unit with snap-type thermostat reaches curing temperature fast.
- ⊙ Controlling with auto time & temperature adaptor.

**PROFESSIONAL
500W**



TUBE PLATE MENDING MACHINE

VG04202 SK350

This machine will make a better repair on the most common sized of tube at a lower cost than any other method.

- ⊙ 220/240V-50/60HZ, 500W.
- ⊙ Working temperature: 180° C
- ⊙ Heating unit dimension: 10 × 17cm.
- ⊙ Manual quick clamping device.
- ⊙ Constant pressure on tube all the time during operation.
- ⊙ Controlling with auto time & temperature adaptor.

**PROFESSIONAL
500W**





TUBE PLATE MENDING MACHINE

VG04203 SK600

This machine will make a better repair on the most common sized of tube at a lower cost than any other method.

- ⊙ 220/240V-50/60HZ, 500W.
- ⊙ Working temperature: 180° C
- ⊙ Heating unit dimension: 10 X 17cm.
- ⊙ Manual quick clamping device.
- ⊙ Constant pressure on tube all the time during operation.
- ⊙ Controlling with auto time & temperature adaptor.
- ⊙ It can mounted on bench or support pillar fixed on the floor.

**PROFESSIONAL
500W**



TUBE PLATE MENDING MACHINE

VG04204 SK500

TRUCK TIRE SHOULDER, TREAD SIDEWALL REPAIRS.

- ⊙ 220/240V-50/60Hz, 1000W.
- ⊙ Working temperature: 165° c
- ⊙ Reduced heat-up time from 15 minutes to less than 5 minutes.
- ⊙ Controlling with auto time & temperature adaptor.
- ⊙ Individual contour plates and accessories are included:
Tyre shoulder (out side)
Tyre shoulder (inner side)
Tyre crown (inner side)
Sidewall (out side)
Sidewall (inner side)
Pliable contour bag

**PROFESSIONAL
1000W**



TUBE MENDING MACHINE

VG04231 YB8602

- ⊙ Motor power: 1.5KW
- ⊙ Power supply: 230v-50Hz
- ⊙ Maximum sulfuration area: 80mmX70mm

Tyres are not transfigured after sulfur-mending and can keep rather good running balance

- ⊙ Numerical control.
- ⊙ Temperature: Outer wheel at about 160°C; Inner wheel at about 155°C.
- ⊙ Time: outer wheel needs 10-20 minutes; Inner wheel needs 5-10 minutes.
- ⊙ Vulcanization: to the inside of the outer wheel, push the power switch and the down model switch; to the outside of the outer wheel and the inner wheel, push the power and up model switch.
- ⊙ Packing size: 700*295*1370mm

**PROFESSIONAL
1500W**

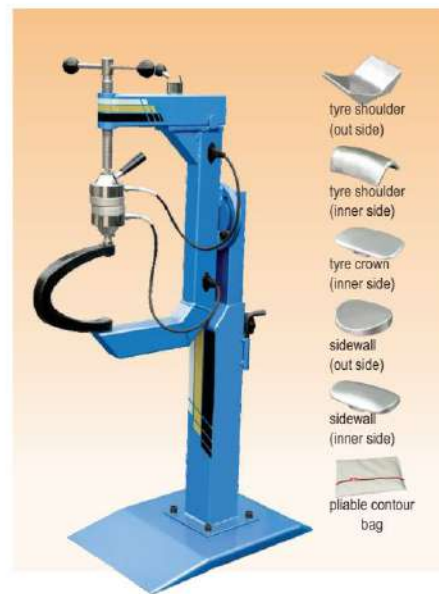

TUBE PLATE MENDING MACHINE

VG04232 YB8601

TRUCK TIRE SHOULDER, TREAD SIDEWALL REPAIRS.

- ⊙ 220/240V-50/60Hz, 1000W.
- ⊙ Working temperature: 165° c
- ⊙ Reduced heat-up time from 15 minutes to less than 5 minutes.
- ⊙ Controlling with auto time & temperature adaptor.
- ⊙ Packing size: 250*550*1200mm
- ⊙ Individual contour plates and accessories are included:
Tyre shoulder (out side)
Tyre shoulder (inner side)
Tyre crown (inner side)
Sidewall (out side)
Sidewall (inner side)
Pliable contour bag

**PROFESSIONAL
2X500W**

WHEEL BALANCER
VG04196 SBM 99A
Technical Specification

Max.wheel weight: 65kg
 Motor Power: 0.2kw
 Power Supply: 110V/220V
 Balancing accuracy: $\pm 1g$
 Balancing speed: 220r.p.m
 Rim diameter: 10" ~24"
 Rim width: 1.5"~20"
 Measuring time: 8s
 Noise level: <70dB
 Packing Size: 960mm*760mm*1240mm
 Weight: 103kg/128kg

Features:

- ▶ For passenger car, motorcycle and light commercial vehicle wheels
- ▶ Automatic distance and wheel diameter measuring
- ▶ Various balancing modes
- ▶ Self-calibration and diagnosis
- ▶ Plastic safe-guard works as the START and STOP button while balancing the wheel by pulling the guard down/up.
- ▶ Optional universal wheel flange, motorcycle adaptor and large centring cone

Auto distance and wheel diameter measuring

WHEEL BALANCER
VG04197 SBM 99B
Technical Specification

Max.wheel weight: 65kg
 Motor Power: 0.2kw
 Power Supply: 110V/220V
 Balancing accuracy: $\pm 1g$
 Balancing speed: 220r.p.m
 Rim diameter: 10" ~24"
 Rim width: 1.5"~20"
 Measuring time: 8s
 Noise level: <70dB
 Packing Size: 960mm*760mm*1240mm
 Weight: 103kg/128kg

Features:

- Ⓞ For passenger car, motorcycle and light commercial vehicle wheels
- Ⓞ Hand-operated distance and wheel diameter input
- Ⓞ Various balancing modes
- Ⓞ Self-calibration and diagnosis
- Ⓞ Plastic safe-guard works as the START and STOP button while balancing the wheel by pulling the guard down/up.
- Ⓞ Optional universal wheel flange, motorcycle adaptor and large centring cone

Hand-operated distance and wheel diameter input
WHEEL BALANCER
VG04198 SBM 96A
Technical Specification

Max.wheel weight: 65kg
 Motor Power: 0.2kw
 Power Supply: 110V/220V
 Balancing accuracy: $\pm 1g$
 Balancing speed: 220r.p.m
 Rim diameter: 10" ~24"
 Rim width: 1.5"~20"
 Measuring time: 8s
 Noise level: <70dB
 Packing Size: 1080mm*800mm*1150mm
 Weight: 105kg/125kg

Features:

- Ⓞ For passenger car, motorcycle and light commercial vehicle wheels
- Ⓞ Hand-operated distance and wheel diameter input
- Ⓞ Various balancing modes
- Ⓞ Self-calibration and diagnosis
- Ⓞ Plastic safe-guard works as the START and STOP button while balancing the wheel by pulling the guard down/up.
- Ⓞ Optional universal wheel flange, motorcycle adaptor and large centring cone

Hand-operated distance and wheel diameter input

STANDART ACCESSORIES FOR BALANCER

BALANCING HAMMER
CALIPER
QUICK RELEASE NUT
CONIC
OPTIONAL ACCESSORIES FOR BALANCER

MOTORCYCLE ADAPTOR OF WHEEL BALANCER
NO-HOLE CONE
LARGE CENTRING CONE

WHEEL BALANCER
VG04236 FS-966A
Technical Specification

Max.wheel weight:	70kg
Max.wheel diameter:	960mm
Motor Power:	0.2-0.25kw
Power Supply:	110V/220V
Balancing accuracy:	± 1g
Balancing speed:	215r.p.m
Rim diameter:	12"-24"
Rim width:	1.5"-20"
① Measuring time:	8s
② Noise level:	<70dB
③ Packing size:	1060*700*920mm

Features:

Self calibration and self diagnosis programs.
 Static and standard dynamic balancing and special rim balancing.
 Unbalance value displayed accurately, and the position to add the balance weight is indicated definitely.

WHEEL BALANCER
VG04238 FS990A
Technical Specification

Max.wheel weight:	70kg
Max.wheel diameter:	960mm
Motor Power:	0.2-0.25kw
Power Supply:	110V/220V
Balancing accuracy:	± 1g
Balancing speed:	215r.p.m
Rim diameter:	12"-24"
Rim width:	1.5"-20"
Measuring time:	8s
Noise level:	<70dB
Packing size:	1140*530*1250mm

Features:

- ① Self calibration and self diagnosis programs.
- ② Static and standard dynamic balancing and special rim balancing.
- ③ Unbalance value displayed accurately, and the position to add the balance weight is indicated definitely.

WHEEL BALANCER
VG04237 FS-968
Technical Specification

Max.wheel weight:	70kg
Max.wheel diameter:	960mm
Motor Power:	0.2-0.25kw
Power Supply:	110V/220V
Balancing accuracy:	± 1g
Balancing speed:	215r.p.m
Rim diameter:	12"-24"
Rim width:	1.5"-20"
Measuring time:	8s
Noise level:	<70dB
Packing size:	1200*700*1200mm

Features:

- ① 3 aluminum alloy rim programs and static program.
- ② Automatic distance and wheel diameter measuring.
- ③ It is equipped with the standard protection cover which has been set up properly. The machine starts with put down the cover and stops when lift up the cover. Or the operator can press the START button.
- ④ There are self-calibration and self-diagnosis functions.
- ⑤ 15" color VGA LCD

TRUCK WHEEL BALANCER
VG04257 CB448B
Technical Specification

Max wheel diameter	1200mm
Machine weight	269.5kg
Wheel width	20"
Power	0.55kw
Load capacity	200kg
Rotation speed	100/200rpm
Accuracy	± 1g/± 10g
Quantity in 20" container	18
Quantity in 40" container	42



It is equipped with the iron quick nut increasing the life of use.



The human-oriented design of the press button board makes you can direct view when operation.



Each machine is equipped with the lift.

TRUCK WHEEL BALANCER

VG04258 CB460B
Technical Specification

Max wheel diameter	1200mm
Machine weight	269.5kg
Wheel width	20"
Power	0.55kw
Load capacity	200kg
Rotation speed	100/200rpm
Accuracy	±1g/±10g
Quantity in 20" container	18
Quantity in 40" container	42



It is equipped with the iron quick nut increasing the life of use.



The human-oriented design of the press button board makes you can direct view when operation. It is also has the car/truck conversion function.



Each machine is equipped with the lift.

TIRE CHANGER
VG04190 BL506/506A
Technical Specification

Motor power:	0.75kw/1.1kw
Power supply:	220v/380v/110v
Max. Wheel diameter:	41"(1040mm)
Max. Wheel width:	10"~21"
Inside clamping:	12"~24"
Air supply:	8bar~10bar
Bead breaker force:	2500kg
Noise level:	<70db
Package size:	108x90x96cm (main body) 160x33x57cm(left help arm) 105x45x43cm(right help arm)
Weight:	358kg/408kg

Features:

- ⊙ The complete bead breaker cylinder made of steel iron, more durable.
- ⊙ The complete clamping cylinder with \varnothing 80 diameter, the seal ring and the piston are integrated, less resistance.
- ⊙ The complete gearbox made of aluminium, light and more durable.
- ⊙ Pneumatically operated tilting column
- ⊙ Simultaneous pneumatic horizontal and vertical arm locker
- ⊙ Capable of handling stiff, wide and low-profile tire
- ⊙ Double help arms
- ⊙ Pneumatic bead breaker
- IA/ Rear air tank serves as tubeless tire inflating device.

Pneumatically operated tilting column with double help arms/tubeless tire inflating system

TIRE CHANGER
VG04191 BL507F/507AF
Technical Specification

Power:	0.75/1.1kw
Power supply:	110V/220V/380V
Max.wheel diameter:	41" (1040mm)
Max.wheel width:	14" (355mm)
Outside clamping:	10" ~21"
Inside clamping:	12"~24"
Air supply:	8bar~10bar
Bead breaker force:	2500kg
Noise level:	<70dB
Packing size:	1080mm*900mm*960mm(main body) 1050mm*450*430mm(right help arm)

Features:

- ⊙ The complete bead breaker cylinder made of steel iron, more durable.
- ⊙ The complete clamping cylinder with \varnothing 80 diameter, the seal ring and the piston are integrated, less resistance.
- ⊙ The complete gearbox made of aluminium, light and more durable.
- ⊙ Pneumatically operated tilting column
- ⊙ Simultaneous pneumatic horizontal and vertical arm locker
- ⊙ Capable of handling stiff, wide and low-profile tire
- ⊙ Right help arm
- ⊙ Pneumatic bead breaker
- IA/ Rear air tank serves as tubeless tire inflating device.

Pneumatically operated tilting column with right help arms/tubeless tire inflating system

TIRE CHANGER
VG04193 BL505F/505AF
Technical Specification

Power:	0.75/1.1kw
Power supply:	110V/220V/380V
Max.wheel diameter:	41" (1040mm)
Max.wheel width:	14" (355mm)
Outside clamping:	10" ~21"
Inside clamping:	12"~24"
Air supply:	8bar~10bar
Bead breaker force:	2500kg
Noise level:	<70dB
Packing size:	1080mm*900mm*960mm(main body) 1050mm*450*430mm(right help arm)

Features:

- ⊙ The complete bead breaker cylinder made of steel iron, more durable.
- ⊙ The complete clamping cylinder with \varnothing 80 diameter, the seal ring and the piston are integrated, less resistance.
- ⊙ The complete gearbox made of aluminium, light and more durable.
- ⊙ Pneumatically operated tilting column
- ⊙ Simultaneous pneumatic horizontal and vertical arm locker
- ⊙ Capable of handling stiff, wide and low-profile tire
- ⊙ Right help arm
- ⊙ Pneumatic bead breaker
- IA/ Rear air tank serves as tubeless tire inflating device.

Pneumatically operated tilting column with right help arms/tubeless tire inflating system



TIRE CHANGER

VG04192 BL505/505A

Technical Specification

Power: 0.75/1.1kw
 Power supply: 110V/220V/380V
 Max.wheel diameter: 41" (1040mm)
 Max.wheel width: 14" (355mm)
 Outside clamping: 10" ~21"
 Inside clamping: 12"~24"
 Air supply: 8bar-10bar
 Bead breaker force: 2500kg
 Noise level: <70dB
 Packing size: 1080mm*900mm*960mm

Features:

- ⊗ The complete bead breaker cylinder made of steel iron, more durable.
- ⊗ The complete clamping cylinder with \varnothing 80 diameter, the seal ring and the piston are integrated, less resistance.
- ⊗ The complete gearbox made of aluminium, light and more durable.
- ⊗ Pneumatically operated tilting column
- ⊗ Simultaneous pneumatic horizontal and vertical arm locker
- ⊗ Pneumatic bead breaker
- /A/ Rear air tank serves as tubeless tire inflating device.

Pneumatically operated tilting column/ + tubeless tire inflating system



TIRE CHANGER

VG04194 BL503/503A

Technical Specification

Power: 0.75/1.1kw
 Power supply: 110V/220V/380V
 Max.wheel diameter: 41" (1040mm)
 Max.wheel width: 14" (355mm)
 Outside clamping: 10" ~21"
 Inside clamping: 12"~24"
 Air supply: 8bar-10bar
 Bead breaker force: 2500kg
 Noise level: <70dB
 Packing size: 1080mm*900mm*960mm

Features:

- ⊗ The complete bead breaker cylinder made of steel iron, more durable.
- ⊗ The complete clamping cylinder with \varnothing 80 diameter, the seal ring and the piston are integrated, less resistance.
- ⊗ The complete gearbox made of aluminium, light and more durable.
- ⊗ Semi-automatic side swing arm
- ⊗ Pneumatic bead breaker
- /A/ Rear air tank serves as tubeless tire inflating device.

Semi-automatic side swing arm+tubeless tire inflating system

TIRE CHANGER

VG04195 BL502

Technical Specification

Power: 0.75/1.1kw
 Power supply: 110V/220V/380V
 Max.wheel diameter: 38" (960mm)
 Max.wheel width: 13" (330mm)
 Outside clamping: 10" ~18"
 Inside clamping: 12"~22"
 Air supply: 8bar-10bar
 Bead breaker force: 2500kg
 Noise level: <70dB
 Packing size: 970mm*750mm*950mm

Features:

- ⊗ The complete bead breaker cylinder made of steel iron, more durable.
- ⊗ The complete clamping cylinder with \varnothing 80 diameter, the seal ring and the piston are integrated, less resistance.
- ⊗ The complete gearbox made of aluminium, light and more durable.
- ⊗ Semi-automatic side swing arm
- ⊗ Pneumatic bead breaker
- ⊗ Optional motorcycle adaptor

Semi-automatic side swing arm



STANDAR ACCESSORIES FOR CHANGER



OPTIONAL ACCESSORIES FOR CHANGER



TIRE CHANGER
VG04233 FS-850 + RH750 + LH650
Technical Specification

Power: 0.75/1.1kw
 Power supply: 110V/220V/400V
 Max.wheel diameter: 41"(1100mm)
 Max.wheel width: 12.5"(315mm)
 Outside clamping: 11"-21"
 Inside clamping: 13"-24"
 Air supply: 8bar-10bar
 Bead breaker force: 2500kg
 Noise level: <70dB
 Packing size: 1100*1300*1800mm

Features:

- ⊗ Pneumatically operated tilting column.
- ⊗ Dual arm system incorporates both the swing arm and pneumatic tilt back arm.
- ⊗ Capable of handling stiff, wide and low-profile tyre.
- ⊗ The clamping jaws and mounting and demounting head are made of high-quality alloy steel and of scientific structural design protects steel rim from any damage during operation.
- ⊗ An air operated wheel lift that helps the operator position the largest of rims onto the turntable with the minimum amount of effort.
- ⊗ Rapid inflation equipment provide faster, safer and more effective inflation to new replace tubeless tyre.

TIRE CHANGER
VG04234 FS-850
Technical Specification

Power: 0.75/1.1kw
 Power supply: 110V/220V/400V
 Max.wheel diameter: 41"(1100mm)
 Max.wheel width: 12.5"(315mm)
 Outside clamping: 11"-21"
 Inside clamping: 13"-24"
 Air supply: 8bar-10bar
 Bead breaker force: 2500kg
 Noise level: <70dB
 Packing size: 920*1050*1800mm

Features:

- ⊗ The enlarged 24" turntable is suitable for mounting/demounting more larger and wider tyre, especially for low profile tyre.
- ⊗ Semi-automatic side swing arm.
- ⊗ Pneumatically operated tilting column.
- ⊗ Helper installation holes have been kept in advance. RH750(helper) is optional, easy for the operation.

TIRE CHANGER
VG04235 FS-813
Technical Specification

Power: 0.75/1.1kw
 Power supply: 110V/220V/400V
 Max.wheel diameter: 41"(1100mm)
 Max.wheel width: 12.5"(315mm)
 Outside clamping: 11"-21"
 Inside clamping: 13"-24"
 Air supply: 8bar-10bar
 Bead breaker force: 2500kg
 Noise level: <70dB
 Packing size: 900*950*1850mm

Features:

- ⊗ The enlarged 24" turntable is suitable for mounting/demounting more larger and wider tyre.
- ⊗ Left help arm system makes the wider tyres mounting/dismounting operation much swift and labor saving.
- ⊗ Scientific and stable design to make sure the wheels and tyres free of damage during operation.

MOTORCYCLE TIRE CHANGER
VG04250 M806
Technical Specification

Max wheel diameter: 960mm
 Machine weight: 175kg
 Rim width: 3"-10"
 Power: 0.75-1.1kw
 Outside clamp: 6"-24"
 Rotation speed: 7rpm
 Quantity in 20" container: 34
 Quantity in 40" container: 72



1. Specially designed tire changer for two and four wheel motorcycle tires
2. Plastic clamping jaw covers protect the rim from damage
3. Special tool head designed specifically for easy mounting & dismounting of motorcycle tires of all sizes
4. The shape of the bead breaker blade will easily break the bead of small, narrow and standard motorcycle tires.
5. The sliding clamping jaws have three positions that will cover from 6" - 24" rims.

SWING ARM CAR TIRE CHANGER
VG04251 LC810

Technical Specification
 Max wheel diameter 960mm
 Machine weight 190kg
 Rim width 3"-12"
 Power 0.75-1.1kw
 Inside clamp 12"-22"
 Outside clamp 10"-28"
 Rotation speed 7rpm
 Quantity in 20" container 34
 Quantity in 40" container 72

1. High quality mount/demount foot will not distort or break under load and will provide years of service.
2. Plastic inserts can be easily fitted to the mount/demount foot when working with alloy wheels.
3. Top quality clamping jaws will perform under all work loads without failure.
4. Optional motorcycle/ATV (all terrain vehicle) adapters can be easily fitted to increase or decrease the clamping range by 4 inches.
5. Space saving and cost efficient swing arm design.
6. Plastic clamping jaw covers prevent damage to alloy wheels.
7. The customer can optional equip the plastic tool head according to hte requirement.

TILT-BACK CAR TIRE CHANGER
VG04252 8871T

Technical Specification
 Max wheel diameter 1030mm
 Machine weight 260kg
 Rim width 3"-15"
 Power 0.8-1.1Kw
 Inside clamp 13"-26"
 Outside clamp 10"-24"
 Rotation speed 7-13rpm
 Quantity in 20" container 20
 Quantity in 40" container 42

1. The use of the bead breaker cylinder makes the bead breaking force much bigger.
2. Hte hexangular shaft adopts the structure of pneumatic spring making the operation easy.
3. The diameter of turntable cylinder is 80mm to increase the clamp force of the jaw on the rim.
4. Semi automatic tire changer. The tilt backward and forward of the column and the lock of the column can be completed pneumatically.
5. The quick deflate valves are installed in front of/at the rear of the bead breaker cylinder, the one-side movement can be completed in about 2-3 seconds.
6. The inflation device has two options including plastic inflation box and metal tool box. Due to the mount of the new style pressure limit valve making the time of the inflation to be decreased by half.
7. The design of the pedal assembly is removable. It is easy to maintenance and exchange.
8. Column adopts the double bend process making it very strong.
9. The horizontal arm adopts 50mm quadric shaft securing the bend resistance strength of the horizontal arm.
10. The turntable with the protective cover which can effectively separate the rim from the surface of the metal surface of the turntable. And make it look more beautiful.
11. The design of the bead breaker blade can rotate at any direction, securing the best bead breaking force. The bead breaker blade is equipped with the protective cover.
12. The bead breaker arm has the 2 travel.
13. Turntable is equipped with the standard parts of wear-resistance washer and scale.

TILT-BACK CAR TIRE CHANGER
VG04253 8851TA

Technical Specification
 Max wheel diameter 1040mm
 Machine weight 240kg
 Rim width 3"-12"
 Power 0.75-1.1kw
 Inside clamp 12"-24"
 Outside clamp 10"-20"
 Rotation speed 7rpm
 Quantity in 20" container 20
 Quantity in 40" container 42

1. Semi automatic tire changer, the tilt backward and forward of the column and The lock of the column can be completed pneumatically.
2. Design of the pedal assembly is removable. It is easy to maintenance and exchange.
3. The quick deflate valves are installed in front of/at the rear of the bead breaker cylinder, the one-side movement can be completed in about 2-3 seconds.
4. The horizontal arm adopts 55mm quadric shaft securing the bend resistance strength of the horizontal arm.
5. The customer can optional equip the plastic tool head according to the requirement.
6. The jaw adopts the special steel with the feature of solid and durable.
7. It adopts S41 hexangular shaft securing the bend resistance strength of the hexangular shaft.
8. IT model is equipped with the quick inflation device to increase the inflation efficiency of the tire.

TILT-BACK CAR TIRE CHANGER
VG04254 8915T+PL330A+AL335

Technical Specification
 Max wheel diameter 1200mm
 Machine weight 355kg
 Rim width 4"-15"
 Power 0.75-1.1kw
 Inside clamp 15"-28"
 Outside clamp 13"-24"
 Rotation speed 7rpm
 Quantity in 20" container 8
 Quantity in 40" container 16

1. Semi automatic tire changer, the tilt backward and forward of the column and the lock of the column can be completed pneumatically.
2. The design of the pedal assembly is removable. It is easy to maintain and exchange.
3. The quick deflate valves are installed in front of/at the rear of the bead breaker cylinder, the one-side movement can be completed in about 2-3seconds.
4. Horizontal arm adopts 55mm quadric shaft securing the anti-bend strength.
5. Claw with the plastic cover is used to protect the rim.
6. Jaw of special material is solid and durable.
7. The use of S41 hexangular shaft secures the anti-bend strength of the hexangular shaft.
8. IT model with the quick inflation device improves the inflation efficiency.
9. Column adopts the double bend process is very strong.
10. The bead breaker arm has two travel.
11. Turntable is equipped with the standard accessories of wear-resistance washer and scale.
12. Horizontal arm is equipped with the horizontal lock cylinder the lock of which is better.

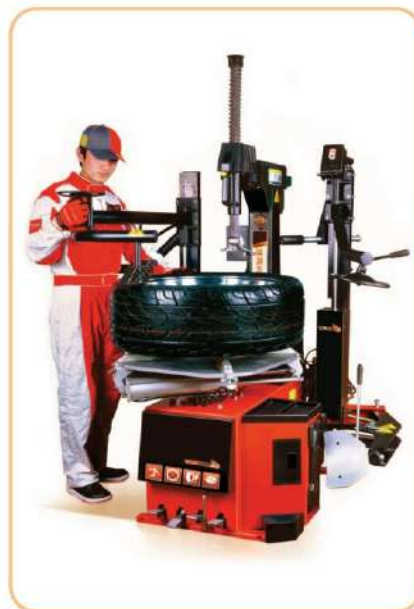

TRUCK TIRE CHANGER
VG04255
LC588
Technical Specification

Max wheel diameter	1500mm
Machine weight	561kg
Wheel width	760mm
Power	1.8kw
Internal clamp	14"-26"
Rotation speed	≈6
Working pressure	150bar
Quantity in 20" container	6
Quantity in 40" container	16



1. It is used to mount/dismount the drop center rim/tubeless wheel/wheel with ring of the passenger car/truck/agriculture vehicle/industrial vehicle.
2. It is equipped with the hydraulic driven carriage making the tire moving on the tire changer without man power.
3. The small and portable console is very convenient to observe from different views avoiding the mis-operation in the process of operation.

2

TRUCK TIRE CHANGER

1. It is a automatic tire changer suitable for mounting/dis mounting tubeless wheel of the van, passenger car and bus and meanwhile for mounting/dismounting the tire with ring.
2. The tool arm can automatically move horizontally and vertically.
3. The tool can manually rotate.
4. The small and portable console is very convenient to observe form different view avoiding the mis-operation in the process of operation.
5. The tool arm and the carriage move synchronously shortening the operation time and improving the working efficiency.

VG04256 LC586
Technical Specification

Max wheel diameter	1280mm
Machine weight	610kg
Wheel width	700mm
Power	1.8kw
Internal clamp	13"-26"
Rotation speed	≈6.5
Working pressure	150bar
Quantity in 20" container	6
Quantity in 40" container	14

1

TIRE INFLATOR
VG04239 FS-302
Technical Specification

Power:	40w
Power supply:	110V/220V/400V
Air input pressure	≤145Psi/10Bar
Air output pressure	65Psi/4.5Bar(safety pressure)
Operation temp	-20°C~+70°C
Measuring range	5~110Psi/0.3~8Bar
Accuracy	±0.5Psi/0.03Bar
Display mode	LED
Packing size:	420*380*1390mm

Features:

- ⊗ Automatic identification and adjustment for required pressure.
- ⊗ High precision testing device.
- ⊗ Unique pressure sensor and encapsulation technics.
- ⊗ Exclusive super large LCD display.
- ⊗ Human-based design, easy and simple to handle.
- ⊗ Adopts safety pressure setting device.

TYRE NITROGEN INFLATOR
VG04240 FS-3500
Technical Specification

Power :	40w
Power supply :	220V
Nitrogen purity:	95-99.5%
compressedAir input range	8-10Kg/cm ² 100-145Psi
Nitrogen output	66L/min(2.3cfm)@145Psi/10Bar
N output pressure	4-7kg/cm ² 58-100Psi
Nitrogen storage tank	70L/18.5gal
Measuring range	5-110Psi/0.3-8Bar
Packing size:	550*730*1440mm

Features:

- ⊗ Equipment adopts high-octane BF-200# carbon molecular sieve.
- ⊗ Fast nitrogen producing can meet the needs of continuing tyre inflation.
- ⊗ For compatible medium, the compressed air is filtered by sophisticated filtration device.
- ⊗ The equipment can do self-regulation to input air pressure to insure the equipments service life.



TWO POST LIFT WITH FLOOR PLATE

VG04259 ATL-YP2-35

Structure	Capacity (kg)	Lift height (mm)	Rise time (S)	Drop time (S)
floor plate	3500	1800	50	22
Power of motor (kw)	Power supply (V)	Machine Height (mm)	Machine Width (mm)	Frame Width (mm)
2.2	380/220	2820	3200	3420

- ⊗ Double cylinder dynamic hoist drive device, capacity is more than 3.5T/4T.
- ⊗ Optional revolving support leg and connected sleeve support leg.
- ⊗ Gum rubber support leg pad, the durability 3 times higher than the common materials.
- ⊗ Aluminum pump system, running time without any break down for at least 40,000 H.
- ⊗ Mechanical lowering control hydraulic pressure configuration. Simple, durable and reliable.

Specification: (mm)

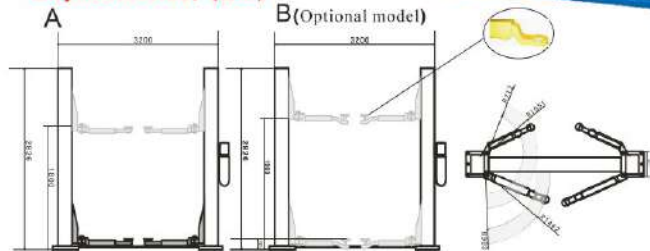

TWO POST LIFT WITH ELECTROMAGNETIC RELEASE

VG04260 ATL-YP2-35E

Structure	Capacity (kg)	Lift height (mm)	Rise time (S)	Drop time (S)
Electromagnetic release	3500	1800	50	22
Power of motor (kw)	Power supply (V)	Machine Height (mm)	Machine Width (mm)	Frame Width (mm)
2.2	380/220	2832	3166	3420

- ⊗ Double cylinder dynamic hoist drive device, capacity is more than 3.5T/4T.
- ⊗ Aluminum pump system, running time without any break down for at least 40,000 H.

Specification: (mm)

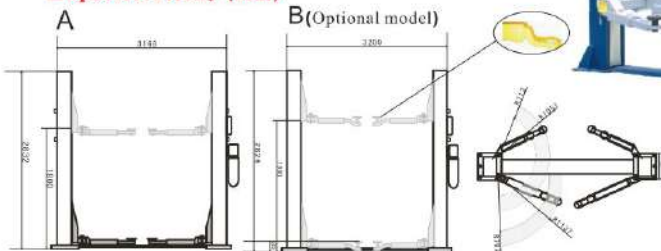

TWO POST LIFT WITH ELECTROMAGNETIC RELEASE

VG04261 ATL-YP2-40SW

Structure	Capacity (kg)	Lift height (mm)	Rise time (S)	Drop time (S)
single point release	4000	1800	54	24
Power of motor (kw)	Power supply (V)	Machine Height (mm)	Machine Width (mm)	Frame Width (mm)
2.2	380/220	3356	3200	3410

- ⊗ Double cylinder dynamic hoist drive device, capacity is more than 4T/5T.
- ⊗ Aluminum pump system, running time without any break down for at least 40,000 H.
- ⊗ Mechanical control hydraulic pressure configuration. Simple, durable and reliable.

Specification: (mm)

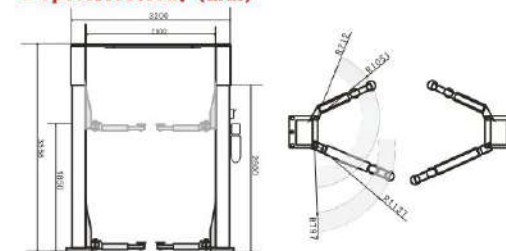

GANTRY LIFT WITH ELECTROMAGNETIC RELEASE

Structure	Capacity (kg)	Lift height (mm)	Risetime (S)	Droptime (S)
electromagnetic release	4000	1800	54	24
Power of motor (kw)	Power supply (V)	Machine Height (mm)	Machine Width (mm)	Frame Width (mm)
2.2	380/220	3556	3200	3410

- ⊙ Double cylinder dynamic hoist drive device, capacity is more than 4T/5T.
- ⊙ Aluminum pump device, running time without any break down for at least 40,000 H.
- ⊙ Mechanical control hydraulic pressure configuration. Simple, endurable and reliable.
- ⊙ Optional revolving support leg and connected sleeve support leg.
- ⊙ Gum rubber support leg pad, the endurability 3 times higher than the common materials.
- ⊙ Equipped dust cover, enhance the life time of steel rope and chain.

■ Specification: (mm)

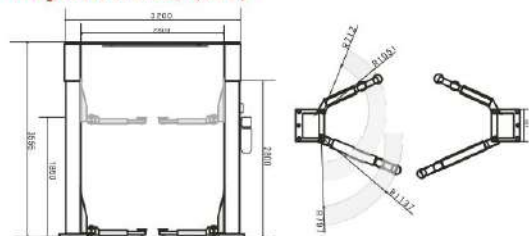

VG04262
ATL-YD2-40EW

CLEAR FLOOR LIFT

Structure	Capacity (kg)	Lift height (mm)	Risetime (S)	Droptime (S)
Clear floor	4000	1800	52	22
Power of motor (kw)	Power supply (V)	Machine Height (mm)	Machine Width (mm)	Frame Width (mm)
2.2	380/220	3601	3254	3427

- ⊙ Double cylinder dynamic hoist drive device, capacity is more than 4T.
- ⊙ Aluminum pump system, running time without any break down for at least 40,000 H.
- ⊙ Mechanical control hydraulic pressure configuration. Simple, endurable and reliable.

■ Specification: (mm)

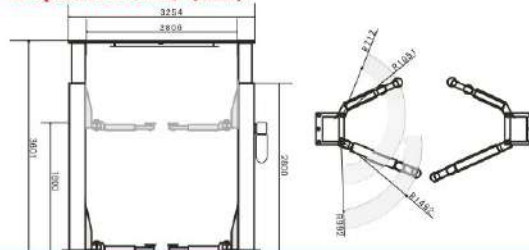

VG04263
ATL-YX2-40

GANTRY LIFT WITH ELECTROMAGNETIC RELEASE

Structure	Capacity (kg)	Lift height (mm)	Risetime (S)	Droptime (S)
electromagnetic release	4000	1800	54	24
Power of motor (kw)	Power supply (V)	Machine Height (mm)	Machine Width (mm)	Frame Width (mm)
2.2	380/220	3601	3200	3427

- ⊙ Double cylinder dynamic hoist drive device, capacity is more than 4T/4.5T.
- ⊙ Aluminum pump system, running time without any break down for at least 40,000 H.

■ Specification: (mm)

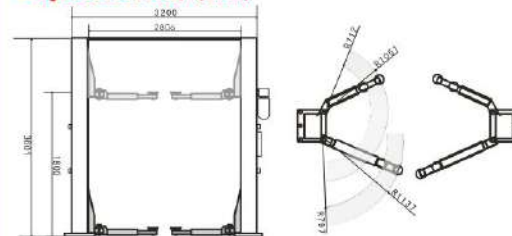

VG04264
ATL-YD2-40E

CLEAR FLOOR LIFT

Structure	Capacity (kg)	Lift height (mm)	Risetime (S)	Droptime (S)
manual release	4000	1800	54	24
Power of motor (kw)	Power supply (V)	Machine Height (mm)	Machine Width (mm)	Frame Width (mm)
2.2	380/220	3601	3200	3427

- ⊙ Double cylinder dynamic hoist drive device, capacity is more than 4T.
- ⊙ Aluminum pump system, running time without any break down for at least 40,000 H.
- ⊙ Mechanical control hydraulic pressure configuration. Simple, endurable and reliable.

■ Specification: (mm)

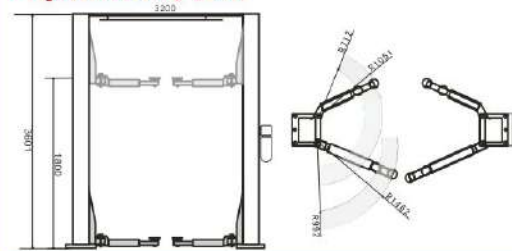

VG04265
ATL-YD2-40

GANTRY LIFT WITH ELECTROMAGNETIC RELEASE

Structure	Capacity (kg)	Lift height (mm)	Rise time (S)	Drop time (S)
electromagnetic release	5000	1900	52	22
Power of motor (kw)	Power supply (V)	Machine Height (mm)	Machine Width (mm)	Frame Width (mm)
3.0	380/220	3680	3496	3775

- ⊗ Double cylinder dynamic hoist drive device, capacity is more than 4T/5T.
- ⊗ Aluminum pump device, running time without any break down for at least 40,000H.

Specification: (mm)

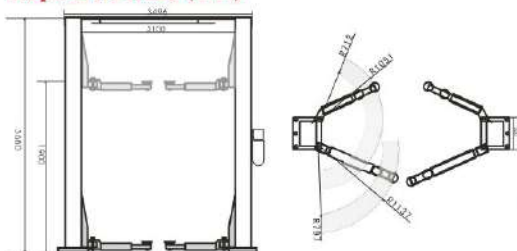

VG04266
ATL-YD2-50E



FOUR POST ALIGNMENT LIFT

Capacity	3500kgs
Power supply	380V/220V
Power of motor	2.2kW
Lift Height	1800mm
Rise/Drop Time	60/50s

1. New high quality 4-post lift, gathering with the advantages from the lift manufactured by overseas or domestic.
2. Polished design, two-layer hidden structure whose capacity is excellent, and 1mm horizontal accuracy.
3. It implements new safe lifting technology of the world as one, included hydraulic control, electrical control and mechanical control.
4. Adjustable position for the turntable of front wheel, and lengthened sliding plate for rear wheel which could satisfy the auto with long or short axle.
5. Open or lock four safety device at one time through one-hand operation.
6. It implements safety device for steel-rope breaking and controlling switch for height limiting to make operator absolutely safe.
7. It is equipped with a secondary lifting jack, electrical & hydraulic control system. And its lifting capacity is 3T.
8. There is 3.5T & 5T lifting capacities for choices.

Specification: (mm)

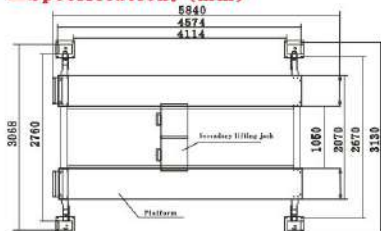

VG04267
ATL-YZ4-35



FOUR POST LIFT

Model	ATL-YP4-35	ATL-YP4-50
Capacity	3500kgs	5000kgs
Power supply	380V/220V	380V/220V
Power of motor	2.2kW	2.2kW
Lift Height	1800mm	1800mm
Rise/Drop Time	60/50s	60/50s

1. New high quality 4-post lift, gathering with the advantages from the lift manufactured by overseas or domestic.
2. Polished design, two-layer hidden structure whose capacity is excellent, and 1mm horizontal accuracy.
3. It implements new safe lifting technology of the world as one, included hydraulic control, electrical control and mechanical control.
4. Open or lock four safety device at one time through one-hand operation.
5. It implements safety device for steel-rope breaking and controlling switch for height limiting to make operator absolutely safe.
6. There is 3.5T/5.0T lifting capacities for choices.

VG04268
ATL-YP4-35/50

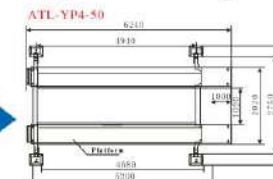
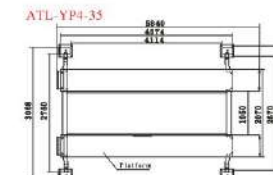

Specification: (mm)

FOUR POST ALIGNMENT LIFT

Capacity	5000kgs
Power supply	380V/220V
Power of motor	3.0kW
Lift Height	1800mm
Rise/Drop Time	60/50s

1. New high quality 4-post lift, gathering with the advantages from the lift manufactured by overseas or domestic.
2. Polished design, two-layer hidden structure whose capacity is excellent, and 1mm horizontal accuracy.
3. It implements new safe lifting technology of the world as one, included hydraulic control, electrical control and mechanical control.
4. Adjustable position for the turntable of front wheel, and lengthened sliding plate for rear wheel which could satisfy the auto with long or short axle.
5. Open or lock four safety device at one time through one-hand operation.
6. It implements safety device for steel-rope breaking and controlling switch for height limiting to make operator absolutely safe.
7. It is equipped with a secondary lifting jack, electrical & hydraulic control system. And its lifting capacity is 3T.
8. There is 5T lifting capacities for choices.

Specification: (mm)

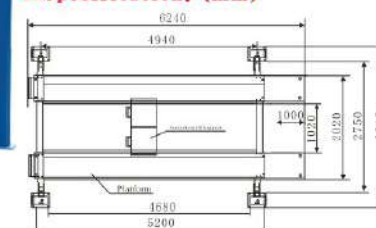

VG04269
ATL-YZ4-50



FOUR POST LIFT FOR 3D ALIGNMENT

Capacity	5000kgs
Power supply	380V/220V
Power of motor	3.0kW
Lift Height	1800mm
Rise/Drop Time	60/50s

1. New high quality 4-post lift, gathering with the advantages from the lift manufactured by overseas or domestic.
2. Polished design, two-layer hidden structure whose capacity is excellent, and 1mm horizontal accuracy.
3. It implements new safe lifting technology of the world as one, included hydraulic control, electrical control and mechanical control.
4. Adjustable position for the turntable of front wheel, and lengthened sliding plate for rear wheel which could satisfy the auto with long or short axle.
5. Open or lock four safety device at one time through one-hand operation.
6. It implements safety device for steel-rope breaking and controlling switch for height limiting to make operator absolutely safe.
7. It is equipped with a secondary lifting jack, electrical & hydraulic control system. And its lifting capacity is 3T.
8. There is 5T lifting capacities for choices.
9. The width of post is 3000mm to satisfy the demand of specific vehicle (1950mm).

VG04270

ATL-YZ4-50/3D



Specification: (mm)

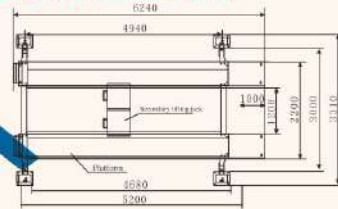

SCISSOR LIFT FOR ALIGNMENT

Host capacity	3500kg
Power supply	AC 380V/220V±1% 50Hz
Original height of platform	300mm
Host lift height	1850mm
Rise and drop time	60s
Gas supply	5-8kg/cm ²
Client capacity	3500kg
Power of motor	2.2kw
Hydraulic oil	20#
Client lift height	450mm
Client rise/drop Time	30/30s

VG04271

ATL-YDJ-2P35



1. Adopt hidden scissors style configuration, compacted dimension
2. Independent control box, Low voltage control, higher safe performance.
3. With functions of claw-lifting safety check and low position Anti foot-crush alarm when lowering.
4. Hydraulic capacity synchronous cylinder, working platform running synchronizedly and smoothly.
5. With Hydraulic lock and mechanical dual-gear safety-claw lock double safety device, automatically open when lowering. By Lock operation can has the safety-claw located adversely, safe & reliable.
6. With the protection of hydraulic pressure fail and overload safety valve.
7. With Pipe anti-crack device to avoid the machine fall down quickly when oil pipe being cracked.
8. Sliding blocks adopt oil free super-wearable materials.
9. Adopt high quality hydraulic and electrical components made by Italy, Germany and Japan, etc.
10. Adopt printed circuit board to avoid the control line and electrical component becomes loose.
11. The level of the lift can be adjusted in high precision, and especially for the four wheel alignment.

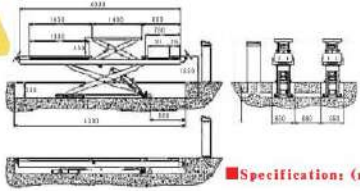

Specification: (mm)



4 WHEEL ALIGNMENT

VG04272

YC-588LH-4D



1. 32" PDP Monitor, Revealing its dignity.
2. Photo navigation Vehicle-On system, to make sure its precision.
3. Digital wide-angle four wheel aligner adopt 4D (4 Point 32 Beam optical measurement) dynamic photo measurement technology, the who process only need <20s.
4. Equipped remote control to actualize long distance operation.
5. Mini printer is optional, save A/5 consumable. Make best use of the technology.
6. Windows XP English Operation system.
7. Digital CCD measurement, accuracy up to ±0.01°, Max wheel diameter 22.5 inch.
8. Intelligent charging system, life time can reach 9000 hours.
9. It has accurate electronic level for both front and rear sensors, with the measurement accuracy ±0.02°.
10. Checking wheel deformation and providing photo illustration.
11. Inaccuracy of repeated measurement up to Int'l Standard ±0.04, can meet the requirements of luxury car, be more accurate of the measurement.
12. Zero point calibration software, the user can perform the self-calibration after the warranty expires.
13. Handhold auxiliary monitor is optional.
14. Human-machine interface, cartoon index of operation procedure, dynamic indicating.
15. Adjustment in-phase between console and sensor intervals 1 seconds only, achieving high efficiency and speed.
16. Checking software of super low chassis.
17. VAG Special program, measure Passat B5, AUDI A6, enclosed video illustration how to perform the adjustment.
18. New audio reminding function, making the operation more convenient and fast.

Item	Measurement Accuracy	Measurement Range	Total Measurement Range
Camber	±0.02°	±4°	±4°
Caster	±0.05°	±18°	±18°
Front wheel KPI	±0.02°	±19°	±19°
Total toe	±0.02°	±26°	±52°
Rear wheel thrust angle	±0.02°	±4°	±4°
Toe-in/out turn	±0.08°	±5°	±19°
Axis effect of Rear wheel	±0.02°	±2°	±4°
Wheel head difference	±0.03°	±2°	±4°
Front setback	±0.02°	±2°	±4°
Rear setback	±0.02°	±2°	±4°
Wheel head	±0.84mm (±0.25in)	(265mm (10.4in))	(265mm (10.4in))
Wheelbase	±0.44mm (±0.25in)	(533mm (21.0in))	(533mm (21.0in))

4: (4 points infrared emitting) D: (Dynamic measurement)

4 WHEEL ALIGNMENT

VG04273

YC-588LH



1. Adopting dynamic measurement technology.
2. Four point transmission, 32-beam measurement.
3. Wide-angle measurement, it can reach ±26 degree.
4. The different angle distributing of four point beam, the maximal measurement range can reach ±26 degree.
5. It solve the problem of blind measurement of single beam, and make sure the high precision of measurement.
6. Three point ROC compensation, it make process within 20 seconds.
7. Adjustment in-phase between console and sensor intervals 1 seconds only, achieving high efficiency and speed.
8. Windows XP English operation system.
9. It has the function of zero-point calibration.
10. Intelligent charging system, life time can reach 9000 hours.
11. Equipped remote control to actualize long distance operation.
12. One key navigation, it can help you to operate easily.
13. Checking wheel deformation and providing photo illustration.
14. It has accurate electronic level for both front and rear sensors, with the measurement accuracy ±0.02°.
15. New audio reminding function, it can be optional.
16. Checking software of super low chassis.
17. VAG Special program, measure PASSAT B5, AUDI A6.

Item	Measurement Accuracy	Measurement Range	Total Measurement Range
Camber	±0.02°	±4°	±4°
Caster	±0.05°	±18°	±18°
Front wheel KPI	±0.02°	±19°	±19°
Total toe	±0.02°	±26°	±52°
Rear wheel thrust angle	±0.02°	±4°	±4°
Toe-in/out turn	±0.08°	±5°	±19°
Axis effect of Rear wheel	±0.02°	±2°	±4°
Wheel head difference	±0.03°	±2°	±4°
Front setback	±0.02°	±2°	±4°
Rear setback	±0.02°	±2°	±4°
Wheel head	±0.84mm (±0.25in)	(265mm (10.4in))	(265mm (10.4in))
Wheelbase	±0.44mm (±0.25in)	(533mm (21.0in))	(533mm (21.0in))

3D mutual action adjustment software



4 WHEEL ALIGNMENT

VG04274 YC-BH888

- ◆ Three dimension adjust interface, mutual action adjust the angle of the auto wheel, show factually the practically change of the wheels.
- ◆ Human and machine mutual action interface, cartoon index for the operation process, operates personally on the scene with dynamic direction.
- ◆ In-jet printer or Mini-printer is optional.
- ◆ Dynamic measurement function available, the whole measure time less than 20 seconds.
- ◆ Adjustment in-phase between console and sensor interval one second only.
- ◆ Measurement error time after time is $\pm 0.04^\circ$, satisfy with the top grade car requirement.
- ◆ More accuracy measurement.
- ◆ Measure accuracy show digital is $\pm 0.01^\circ$.
- ◆ Car model wheel rim diameter max 22".
- ◆ Portable assistant monitor is optional.

Item	Measurement Accuracy	Measurement Range
Toe	$\pm 0.01^\circ$	$\pm 8^\circ$
Camber	$\pm 0.01^\circ$	$\pm 12^\circ$
Caster	$\pm 0.02^\circ$	$\pm 18^\circ$
Font/Rear Setback	$\pm 0.01^\circ$	$\pm 4^\circ$
SAI/KPI	$\pm 0.02^\circ$	$\pm 18^\circ$
Thrust angle	$\pm 0.01^\circ$	$\pm 6^\circ$



TRUCK ALIGNMENT SYSTEM

VG04275 YC-808D

1. Applicable to the repair work for truck, vans, long trailers, buses and other commercial vehicle models of various types.
2. The database covers more than 8000 large vehicle models around the world.
3. It adopts optical graphical sensing and Bluetooth communication.
4. It is capable of measuring vehicle models with long wheel base of 15 meters at most.
5. It uses 4/8 pieces of sensors, achieving a fully-realized 4-wheel alignment system mode with 32-beam optical measurement.
6. It is equipped with truck turntable, each supporting 10T at the most.
7. It has functions for customer management and data printing.
8. Thrust angle can be accurately adjusted by its accurate calculation on the axle adjustment measurement.
9. It is equipped with necessary tools, such as the wheel track ruler (tread ruler) and the relevant device for the central frame of the trailer, to meet the need of repair work for vans and trailers.
10. It can measure all trucks, trailers, buses etc. 10 types of axle construction, including truck structure, semi-trailer structure, bus structure and trailer structure (optional) and so on.
11. Windows XP English operating system, which is easy to learn.
12. Electronic clinometer offered can be used to check the levelness of the vehicle frame, lift and the operating site (the function for deviation compensation of the operating platform is optional).
13. Many frequency channels are set in the software so as to avoid the interferences when many alignment machines working together.
14. It adopts 2.4G frequency wireless communication, which has strong force of penetration even blocked.
15. Tuning Mode is used in the signal transmission process, assuring excellent communication link.
16. The main board of the sensors adopts transducers imported from USA, thus with a long life time and high accuracy.
17. The main board of the sensors adopts surface-mounted technics, and CPU American microchip double-core technology. And such low power consumption makes the fault rate approaching zero.

Item	Measurement Accuracy	Measurement Range	Total Measurement Range
Camber	$\pm 0.02^\circ$	$\pm 8^\circ$	$\pm 8^\circ$
Caster	$\pm 0.03^\circ$	$\pm 18^\circ$	$\pm 18^\circ$
Front wheel KPI	$\pm 0.02^\circ$	$\pm 18^\circ$	$\pm 18^\circ$
Total Toe	$\pm 0.02^\circ$	$\pm 26^\circ$	$\pm 52^\circ$
Rear wheel thrust angle	$\pm 0.03^\circ$	$\pm 4^\circ$	$\pm 4^\circ$
In-out on turn	$\pm 0.08^\circ$	$\pm 5^\circ$	$\pm 10^\circ$
Axle offset of Rear wheel	$\pm 0.03^\circ$	$\pm 2^\circ$	$\pm 4^\circ$
Wheel track difference	$\pm 0.03^\circ$	$\pm 2^\circ$	$\pm 2^\circ$
Front setback	$\pm 0.02^\circ$	$\pm 2^\circ$	$\pm 4^\circ$
Rear setback	$\pm 0.02^\circ$	$\pm 2^\circ$	$\pm 4^\circ$
Wheel track	$\pm 0.44mm (\pm 0.23in)$	$< 265mm (\pm 105in)$	$< 265mm (\pm 105in)$
Wheelbase	$\pm 0.04cm (\pm 0.20in)$	$< 523cm (\pm 210in)$	$< 523cm (\pm 210in)$



4 WHEEL ALIGNMENT

VG04276 YC-RF-565

- ◆ Electronic level for front and rear sensors, accuracy to $\pm 0.04^\circ$.
- ◆ A special function can prove the wheel rim distortion.
- ◆ One key navigation, it can help you to operate easily.
- ◆ It can measure the cars when they are on the un-level lift (allow tolerance max to 0.3").
- ◆ Build-in self calibration procedure. Customer could calibrate the sensor with optional calibration fixture.
- ◆ Camber lockup function, help you to adjust camber after lifting the axle.
- ◆ Refurbish two seconds between the measurement and adjustment.

Item	Measurement Accuracy	Measurement Range
Toe	$\pm 0.02^\circ$	$\pm 6^\circ$
Camber	$\pm 0.02^\circ$	$\pm 12^\circ$
Caster	$\pm 0.03^\circ$	$\pm 18^\circ$
Font/Rear Setback	$\pm 0.02^\circ$	$\pm 4^\circ$
SAI/KPI	$\pm 0.03^\circ$	$\pm 18^\circ$
Thrust angle	$\pm 0.02^\circ$	$\pm 6^\circ$



CAR & TRUCK ALIGNMENT SYSTEM

VG04277 YC-808XD2

Features(For Car alignment):

1. Windows XP English operating system, easy to understand and learn.
2. It is with Bluetooth communication and 7 times' Intelligent anti-interference Frequency hopping; It can still normally communicate through a wall with a range of 50 meter as its diameter.
3. Equipped remote control to actualize long distance operation.
4. One key navigation, it can help you to operate easily.
5. It has accurate electronic level for both front and rear sensors, with the measurement accuracy $\pm 0.02^\circ$.
6. Checking wheel deformation and providing photo illustration.
7. It is fixed with horizontal error compensation functions for lift's horizontal error. (It can bear the tolerance within 0.3").
8. Zero point calibration function.
9. It has MagnetiAm suspension function, capable of meeting the adjustment conditions while lifting both front and rear wheels.
10. Adjustment in-phase between console and sensor intervals 1 seconds only, achieving high efficiency and speed.
11. Intelligent charging system, life time can reach 8000 hours.
12. It has professional adjustment program for AUDI A6 & PASSAT B5 together with Video Demos.
13. Super-low chassis vehicles can be detected.
14. Three point ROC compensation, it make process within 20 seconds.
15. New audio reminding function, making the operation more convenient and fast.
16. The Caster and KPI are measured using the data of optical-turn measurement, more convenient and quicker.
17. Dynamic measurement function imitates 3D measurement process, with the whole interval <20s.

Technical data is same as YC-588LH

Features(For Truck alignment):

1. Applicable to the repair work for truck, vans, long trailers, buses and other commercial vehicle models of various types.
2. The database covers more than 8000 large vehicle models around the world.
3. It adopts optical graphical sensing and Bluetooth communication.
4. It is capable of measuring vehicle models with long wheel base of 15 meters at most.
5. It uses 4/8 pieces of sensors, achieving a fully-realized 4-wheel alignment system mode with 32-beam optical measurement.
6. It is equipped with truck turntable, each supporting 10T at the most.
7. It has functions for customer management and data printing.
8. Thrust angle can be accurately adjusted by its accurate calculation on the axle adjustment measurement.
9. It is equipped with necessary tools, such as the wheel track ruler (tread ruler) and the relevant device for the central frame of the trailer, to meet the need of repair work for vans and trailers.
10. It can measure all trucks, trailers, buses etc. 10 types of axle construction, including truck structure, semi-trailer structure, bus structure and trailer structure (optional) and so on.
11. Windows XP English operating system, which is easy to learn.
12. Electronic clinometer offered can be used to check the levelness of the vehicle frame, lift and the operating site (the function for deviation compensation of the operating platform is optional).
13. Many frequency channels are set in the software so as to avoid the interferences when many alignment machines working together.
14. It adopts 2.4G frequency wireless communication, which has strong force of penetration even blocked.
15. Tuning Mode is used in the signal transmission process, assuring excellent communication link.
16. The main board of the sensors adopts transducers imported from USA, thus with a long life time and high accuracy.
17. The main board of the sensors adopts surface-mounted technics, and CPU American microchip double-core technology. And such low power consumption makes the fault rate approaching zero.

Technical data is same as YC-808D





4 WHEEL ALIGNMENT

VG04278 **YC-RF-585**

- ◆ Electronic level for front and rear sensors, accuracy to $\pm 0.04^\circ$.
- ◆ A special function can prove the wheel rim distortion.
- ◆ One key navigation, it can help you to operate easily.
- ◆ It can measure the cars when they are on the un-level lift (allow tolerance max to 0.3°).
- ◆ Build-in self calibration procedure. Customer could calibrate the sensor with optional calibration fixture.
- ◆ Camber lockup function, help you to adjust camber after lifting the axle.
- ◆ Refurbish two seconds between the measurement and adjustment.

Item	Measurement Accuracy	Measurement Range
Toe	$\pm 0.02^\circ$	$\pm 6^\circ$
Camber	$\pm 0.03^\circ$	$\pm 12^\circ$
Caster	$\pm 0.03^\circ$	$\pm 18^\circ$
Front/Rear Setback	$\pm 0.02^\circ$	$\pm 4^\circ$
SAI/KPI	$\pm 0.03^\circ$	$\pm 18^\circ$
Thrust angle	$\pm 0.02^\circ$	$\pm 6^\circ$



4 WHEEL ALIGNMENT

VG04280 **YC-KT-208**

- ◆ Windows XP English operation system, 17" color monitor.
- ◆ Wireless communication sensor.
- ◆ 360 degree close measurement.
- ◆ Adopt geometry center line and thrust line principle to implement five wheels alignment.
- ◆ One key transmit, it can operate on sensors or mouse.
- ◆ Open style database, the users could input by themselves.
- ◆ Client management function and print-out function.
- ◆ Quickly battery charge system, it works 10 hours continuously.

Item	Measurement Accuracy	Measurement Range
Toe	$\pm 0.04^\circ$	$\pm 4^\circ$
Camber	$\pm 0.04^\circ$	$\pm 10^\circ$
Caster	$\pm 0.04^\circ$	$\pm 12^\circ$
Front/Rear Setback	$\pm 0.04^\circ$	$\pm 2^\circ$
SAI/KPI	$\pm 0.04^\circ$	$\pm 18^\circ$
Thrust angle	$\pm 0.04^\circ$	$\pm 4^\circ$



4 WHEEL ALIGNMENT

VG04279 **YC-RF-525**

- ◆ Electronic level for front and rear sensors, accuracy to $\pm 0.04^\circ$.
- ◆ A special function can prove the wheel rim distortion.
- ◆ One key navigation, it can help you to operate easily.
- ◆ It can measure the cars when they are on the un-level lift (allow tolerance max to 0.3°).
- ◆ Build-in self calibration procedure. Customer could calibrate the sensor with optional calibration fixture.
- ◆ Camber lockup function, help you to adjust camber after lifting the axle.
- ◆ Refurbish two seconds between the measurement and adjustment.

Item	Measurement Accuracy	Measurement Range
Toe	$\pm 0.02^\circ$	$\pm 6^\circ$
Camber	$\pm 0.02^\circ$	$\pm 12^\circ$
Caster	$\pm 0.03^\circ$	$\pm 18^\circ$
Front/Rear Setback	$\pm 0.02^\circ$	$\pm 4^\circ$
SAI/KPI	$\pm 0.03^\circ$	$\pm 18^\circ$
Thrust angle	$\pm 0.02^\circ$	$\pm 6^\circ$



4 WHEEL ALIGNMENT

VG04281 **YC-KT-206**

- ◆ Windows XP English operation system, 17" color monitor.
- ◆ Wireless communication sensor.
- ◆ 360 degree close measurement.
- ◆ Adopt geometry center line and thrust line principle to implement five wheels alignment.
- ◆ One key transmit, it can operate on sensors or mouse.
- ◆ Open style database, the users could input by themselves.
- ◆ Client management function and print-out function.
- ◆ Quickly battery charge system, it works 10 hours continuously.

Item	Measurement Accuracy	Measurement Range
Toe	$\pm 0.04^\circ$	$\pm 4^\circ$
Camber	$\pm 0.04^\circ$	$\pm 10^\circ$
Caster	$\pm 0.04^\circ$	$\pm 12^\circ$
Front/Rear Setback	$\pm 0.04^\circ$	$\pm 2^\circ$
SAI/KPI	$\pm 0.04^\circ$	$\pm 18^\circ$
Thrust angle	$\pm 0.04^\circ$	$\pm 4^\circ$